



How to Pack

Whether you're looking for general guidelines for packing day-to-day shipments or specific guidelines for shipping specialty items, you'll find it all here in our series of comprehensive packaging guides. Click the one you want. Print just what you need.



Click the guide you want.

General Packaging Guidelines **3**

Packaging Perishable Shipments **9**

Packaging Flowers and Plants **17**

Packaging Computer Shipments **21**

Packaging Clinical Samples **27**

Packaging UN 3373 Shipments **31**

Automotive and Mechanical Parts **35**

Packaging Battery Shipments **43**



General Packaging Guidelines

At FedEx, we know proper packaging can help ensure that your shipments arrive safely. So we offer general packaging guidelines — from measuring and weighing your package, to packing methods, sealing and labeling instructions, and guidelines for restricted shipments.

Contents

Shipment Size and Weight Restrictions	4
General Packaging Guidelines	4
General Packing Methods	5
Sealing Your Package	6
Addressing and Labeling Your Package	6
Packaging Specialty Shipments	6



Shipment Size and Weight Restrictions

- With FedEx Express® U.S. services, you can ship packages up to 150 lbs.; up to 119" in length and 165" in length and girth.
- With FedEx Express international services, you can ship packages up to 150 lbs.; up to 108" in length and 130" in length and girth.
- With FedEx Express® Freight Services, you can ship individual skids of 150 lbs. or more. Skids exceeding 2,200 lbs. in weight or exceeding 70" in height, 119" in length, or 80" in width require prior approval.
- With FedEx Ground® services, you can ship packages up to 150 lbs.; up to 108" in length and 165" in length plus girth.
- With FedEx Home Delivery® services, you can ship packages up to 70 lbs.; up to 108" in length and 165" in length plus girth.

Place yellow and black safety heavyweight labels over the diagonal corners of your package if it weighs more than 75 lbs. To get the labels, contact your FedEx Express courier or FedEx account executive, or go to a FedEx Office® Print and Ship Center or FedEx World Service Center®.

Measuring Length and Girth

Length and Girth Formula

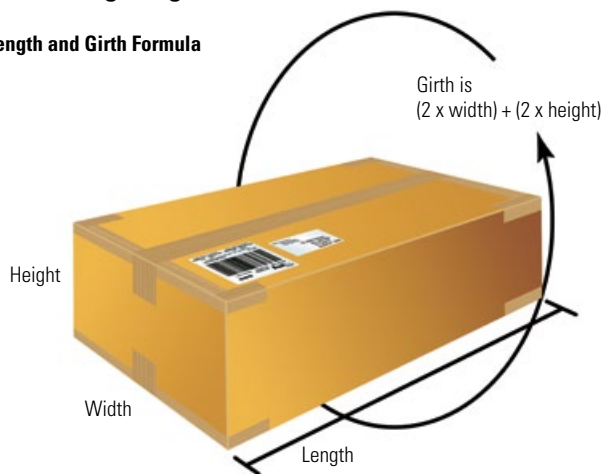

Length is the longest side of the package or object.

The length and girth formula is simple. Here's what you do:

- Measure the length, height, and width of the package.
- Length and girth equals length plus twice the width and twice the height.

Calculating Dimensional Weight

Dimensional weight applies when your package is relatively light compared with its volume. If the dimensional weight exceeds the actual weight, charges based on the dimensional weight will be assessed. To calculate it:

- Multiply length by width by height in inches.
- Divide by 166 (for U.S. and Puerto Rico shipments) or 139 (for international shipments).
- Compare the dimensional weight and actual weight.

General Packaging Guidelines

- Use FedEx Express packaging for FedEx Express package shipments only; any other use is prohibited.
- You may use your own packaging if boxes are sturdy and undamaged with all flaps intact.
- Chipboard boxes, such as gift or shoe boxes, must be packed into a corrugated outer box.
- Use double-wall boxes for heavier items.
- Place small packages inside a larger outer box. For express shipments smaller than 7" x 4" x 2", use a FedEx Express packaging option.
- Double-box fragile items with 3" of cushioning in and around the smaller box.
- Wrap items individually with cushioning material and center them in cartons away from other items and away from the sides, corners, top, and bottom of the box.
- Position bottles that contain liquids upright. Use an inner seal and perforated breakaway cap. The inner packaging must be able to contain leaks.
- Place items that might be damaged by normal handling, such as soiling, marking, or application of adhesive labels, in a protective outer box.
- For odd- or irregular-shaped items, at a minimum you should wrap and tape all sharp edges or protrusions.
- Enclose an extra label, business card, or letterhead with the shipper's address and phone number and the recipient's address and phone number inside the package before sealing it.
- Remove all old address labels from reused boxes before shipping, and make sure there are no holes, tears, or corner dents in the outer box.

General Packing Methods

Follow these general guidelines for the two most popular packing methods, plus recommendations for odd- or irregular-shaped shipments.

Single-Box Packing Method

- Ship nonfragile products like soft goods inside a sturdy outer box.
- Use fillers like crumpled newspaper, loosefill peanuts, or air-cellular cushioning material such as Bubble Wrap® to fill void spaces and prevent movement of goods inside the box during shipping.
- Place goods that might be affected by dirt, water, or wet conditions inside a plastic bag.
- Consolidate small parts or spillable granular products in a strong sealed container, such as a burlap or siftproof plastic bag, then package in a sturdy outer box.
- Use the H taping method for [sealing your package](#).

Single-Box With Wrapped Item

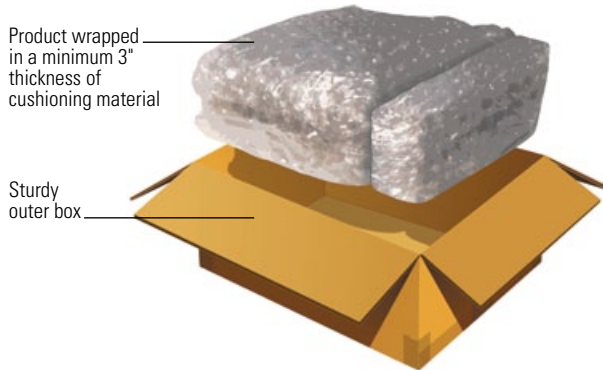

Single-Box Filled With Loosefill Peanuts

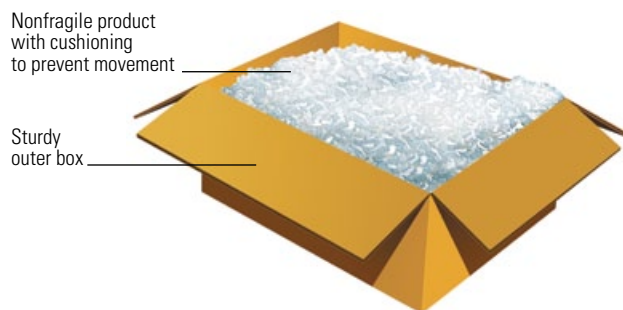

Box-in-Box Packing Method

- Wrap product(s) individually with at least 2" thickness of air-cellular cushioning or foam material to fit snugly inside a corrugated box.
- Restrict product movement inside the box using filler like crumpled newspaper, loosefill peanuts, or other cushioning material.
- Close and tape the inner box using the H taping method. This will help prevent accidental opening.
- Use a second box that is at least 6" longer, wider, and deeper than the inner box.
- Choose the wrap or fill method to cushion the inner box inside the larger sturdy outer box.
- Ship fragile products individually, wrapping them in a minimum 3" thickness of air-cellular cushioning material.
- Wrap the inner box with 3" thickness of air-cellular cushioning material or use at least 3" of loosefill peanuts or other cushioning material to fill the spaces between the inner box and outer box on the top, bottom, and all sides.
- Fill any void spaces with more cushioning material.
- Use the H taping method for [sealing your package](#).

Box-in-Box With Loosefill Peanuts

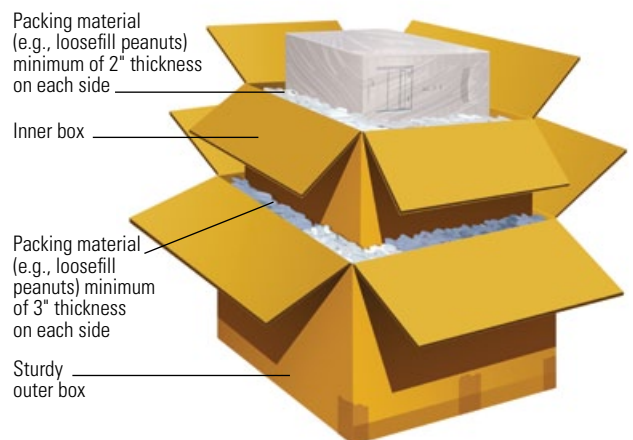

Box-in-Box With Air-Cellular Cushioning

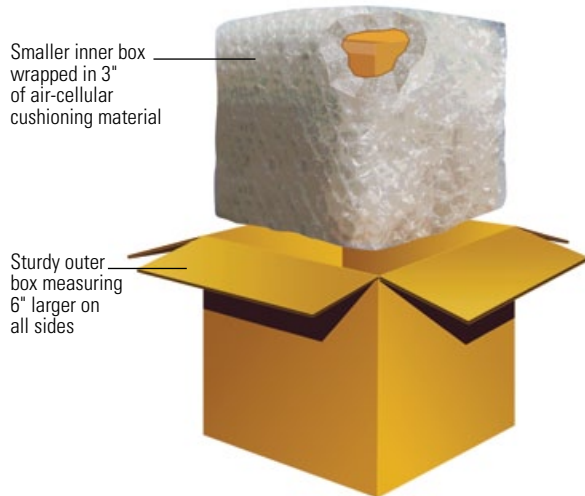

- Package labels and packing slips should be applied facing the same direction on the same side of the package.
- Avoid wrapping labels around the corner or directly on the edge or seam of the package.
- Place shipping labels on the package's largest surface. While we cannot ensure compliance with markings such as "Up" arrows or "This End Up," properly placing the shipping label increases your chance for the preferred orientation.
- Use tie-on tags on transit cases (including tradeshow display cases), golf bags, skis, and luggage.

Sealing Your Package

- Use pressure-sensitive plastic tape, water-activated paper tape (minimum 60-lb. grade), or water-activated reinforced tape that is at least 2" wide.
- Apply tape evenly across flaps and seams to both the top and bottom of the outer box. Use the H taping method.
- Do not use cellophane tape, duct tape, masking tape, string, or rope to seal packages.

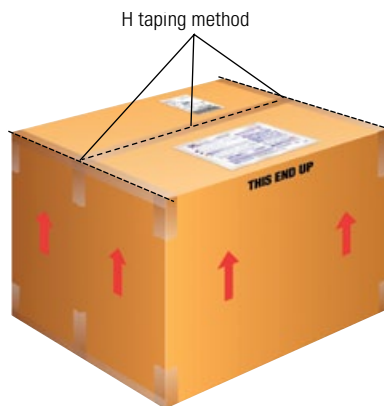

Use applicable routing label, airbill, or address label



Packaging Specialty Shipments

Some shipments require detailed instructions for proper packaging to ensure intact delivery to your destination. We suggest that you download those stand-alone PDF files in their entirety. Guidelines for packaging specialty items contain specific packing, sealing, labeling, and testing instructions. You'll find specific guidelines for those products in the [table of contents](#). Recommendations for items that don't require such specific guidelines follow.

Addressing and Labeling Your Package

- Place delivery information inside and outside the package. Include an address for your recipient and yourself.
- Do not list a P.O. box address for U.S. recipients. FedEx Express can ship to a P.O. box in certain international locations, including Puerto Rico, but you must provide a valid telephone, fax, or telex number.
- Remove or cross out any old address labels on the outer box.

General Guidelines for Unique Items

- **Artwork.** Apply masking tape in a criss-cross pattern on the glass surface to prevent glass from splintering; call the FedEx packaging hotline at 1.800.633.7019 for a list of artwork-packaging manufacturers.
- **Photos and Posterboard.** Tape flat items onto a rigid material like plywood, plastic, or layers of fiberboard padding; as an alternative, place printed material between pieces of corrugated pad and tape both pads together at all seams.
- **Undeveloped Film.** Prominently mark packages containing undeveloped film. Special labels are available. Ask your FedEx courier or call 1.800.GoFedEx 1.800.463.3339 (say "order shipping supplies").
- **Stringed Musical Instruments.** Loosen the tension on the strings to remove the stress on the neck of the instrument.
- **Printed Matter.** Bundle printed material together to prevent shifting. Cushion sufficiently before packing into a double-walled corrugated outer box.
- **Rolled Goods.** Tightly wrap rolled goods using several layers of heavy-duty plastic film or kraft paper and wrap with plastic packing tape. Then wrap the address label completely around the object or use a pouch. FedEx cannot assume liability for damage due to inadequate protection.

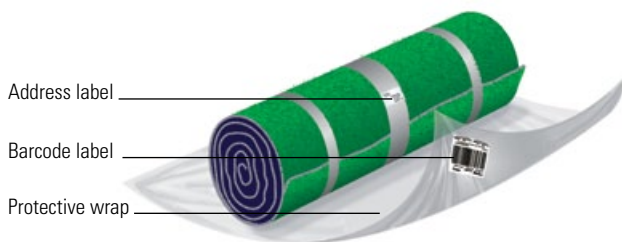

Banker Box, Storage Box, Archive Box, Document Box, Copy Paper Box

These boxes are designed for palletized transport and storage, not individual transport. However, such boxes can be shipped successfully with proper reinforcement and within certain parameters. FedEx will accept such shipments, but the following criteria are strongly recommended:

- The total weight of the shipment should not exceed 30 lbs.
- Use only new, undamaged boxes for shipping. Used boxes are more likely to result in loss of or damage to the contents.
- Secure the box with 2"- to 3"-wide plastic pressure-sensitive shipping tape around the length, width, and perimeter of the box in two places. Upon completion the tape should resemble a "tic-tac-toe" pattern on all sides of the box.
- If the box is not completely full of product, fill all void areas with packing material, e.g., Bubble Wrap, crumpled kraft paper (not newspaper), or loosefill peanuts.
- For identity purposes, apply a shipping label to both the lid and the side of the base for two-piece box shipments.

If the above recommendations are not satisfied and the shipment cannot be brought to compliance, place the material in a new corrugated box or use a box-in-a-box of proper size and strength for the weight of product being shipped.

Dangerous Goods Shipments via FedEx Express

Dangerous goods must be tendered to FedEx Express according to both current International Air Transport Association (IATA) regulations for air transport and the FedEx Express Terms and Conditions.

If you have other questions, call the FedEx Dangerous Goods/Hazardous Materials hotline at 1.800.GoFedEx 1.800.463.3339; press "81" or say "dangerous goods."

To find updated dangerous goods guidelines, information on packaging guidelines, and other information, go to [fedex.com/us/services/options](https://www.fedex.com/us/services/options), then select

Dangerous Goods. You can also register at fedex.com/us/services/options/dangerousgoods/seminars.html for IATA and International Civil Aviation Organization (ICAO) training that meets government-mandated training under 49 Code of Federal Regulations (49CFR) 172.700. To speak with a dangerous goods shipping professional, call 1.800.GoFedEx 1.800.463.3339; press "81" or say "dangerous goods."

Hazardous Materials Shipments via FedEx Ground

If you haven't shipped hazardous materials via FedEx Ground before, contact your FedEx account executive first. We need to confirm that you've met government training requirements and can generate the documentation your shipment needs.

To find updated hazardous materials guidelines, information on packaging guidelines, and other information, go to fedex.com/us/services/options, then select Hazardous Materials. To register for online training that meets Department of Transportation (DOT) certification requirements, go to www.shipsafeshipsmart.com or call 1.800.762.3744, ext. 6753. To speak with a hazardous materials shipping professional, call 1.800.GoFedEx 1.800.463.3339; press "81" or say "dangerous goods."

Bubble Wrap is a registered trademark of Sealed Air Corporation.

NOTICE: This packaging brochure is provided to FedEx customers to help reduce loss or damage due to improper packaging. It is NOT intended to be a comprehensive guide for packaging items we accept for transit. We make no warranties, expressed or implied, regarding this information. Proper packaging is the sole responsibility of the shipper. For more information and additional guidelines, go to the packaging tips page on fedex.com/packaging, email packagingservices@fedex.com, or contact FedEx Packaging Services at 1.800.633.7019. Refer to the current FedEx Service Guide for terms, conditions, and limitations applicable to FedEx® delivery services.

© 2012 FedEx. All rights reserved.

Packaging Perishable Shipments

To help prevent spoilage and maintain product integrity, follow these instructions for shipping your perishable items via FedEx Express® services.

Contents

Preparing Perishable Items for Shipment	10
How to Keep Products Refrigerated During Transit	11
How to Keep Products Frozen During Transit	12
Shipping Seafood With Wet Ice	14
How to Protect Products From Freezing	14
Sealing and Labeling Instructions	15
The FedEx Express Transportation Environment	15
FedEx Package Testing and Design Services	15
Contacts and Resources	16



Preparing Perishable Items for Shipment

Perishable products may be subjected to harsh environmental conditions, such as excessive temperature or humidity, on the way to their destination. We do not provide temperature-controlled shipping services for express shipments. However, with careful packaging, you can protect your products by providing appropriate temperature protection or stability.

During shipping, insulation and refrigerants are key to preserving products like seafood, plants, meat, and fruits as well as dairy, medical, and chemical products. With the proper combination of insulation and refrigerants, you can maintain products within specific temperature ranges. You can keep products frozen, or prevent products from freezing. You can prevent melting and thawing in hot weather and minimize the effects of short-term temperature variations. We'll show you how.

Insulation

We recommend insulation to reduce the transfer of heat through packaging container walls. The most common insulation materials are expanded polystyrene (EPS) foam, rigid polyurethane foam, and reflective materials (radiant barrier films).

Refrigerants

We recommend refrigerants such as gel coolants and dry ice* to keep perishable products cold or frozen. However, do not use dry ice as a refrigerant for live seafood such as lobsters; use gel coolants instead. Wet ice has many disadvantages, including weight and special water-resistant packaging requirements, but it may be used if properly prepared to prevent leakage.

General Guidelines for Packaging Perishables

- Package shipments to withstand handling in different orientations.
- Use a refrigerant that will keep products within the required temperature range. Use gel coolants for refrigerating products between 32 F (0 C) and 60 F (16 C). Use dry ice* for frozen items.

* Dry ice (carbon dioxide solid, UN 1845) is considered a dangerous good/hazardous material for air transport and requires special handling. See *Dry Ice Shipping Regulations* for details.

- Use insulated foam containers with a minimum of 1-1/2"-thick walls.
- Bag perishable products that can melt or thaw, or shipments that contain liquid, using minimum 2-mil watertight plastic bags.
- Place foam containers inside sturdy outer containers.
- Include the address and 24-hour phone number of both the shipper and the recipient on each shipping label.

Express Service Recommendations

- We recommend that perishables be shipped via FedEx First Overnight®, FedEx Priority Overnight®, FedEx Standard Overnight®, or FedEx 1Day® Freight.
- The maximum acceptable gross weight per package for most FedEx Express overnight services is 150 lbs., including packaging and refrigerant.
- For overnight shipment of packages with a gross weight of 151 to 2,200 lbs. each, use FedEx 1Day Freight.
- We recommend that you package perishables for a minimum transit time of 30 hours.
- FedEx does not recommend shipping perishables via FedEx 2Day®, FedEx 2Day® Freight, or FedEx Express Saver®, but if you choose to you should package shipments for at least 12 hours more than the delivery commitment time.
- Avoid shipment of perishable items on days that will require transit on a weekend or over a holiday period.
- Perishable seafood items are acceptable for shipments within the U.S. only.

How to Keep Products Refrigerated During Transit

Gel coolants are preferable to wet ice.

- Freeze the coolants according to the manufacturer's guidelines.
- Precool the insulated container, if possible.
- If your shipment contains liquid or perishable products that could contain liquids, double-bag the products using minimum 2-mil watertight plastic bags and line the inside of the foam container with a minimum 2-mil plastic liner and absorbent material.
- Arrange products inside the insulated container, allowing space for coolants.
- Place a sufficient number of coolants on top of and around the product.
- Fill all void space with dunnage such as loosefill peanuts to prevent product movement.
- Close the liner bag securely.
- Place the insulated container inside a corrugated outer box.
- Close and securely seal the corrugated box with pressure-sensitive plastic tape. Apply the tape over all box flaps and seams.

Packaging Perishable Shipments With Gel Coolants

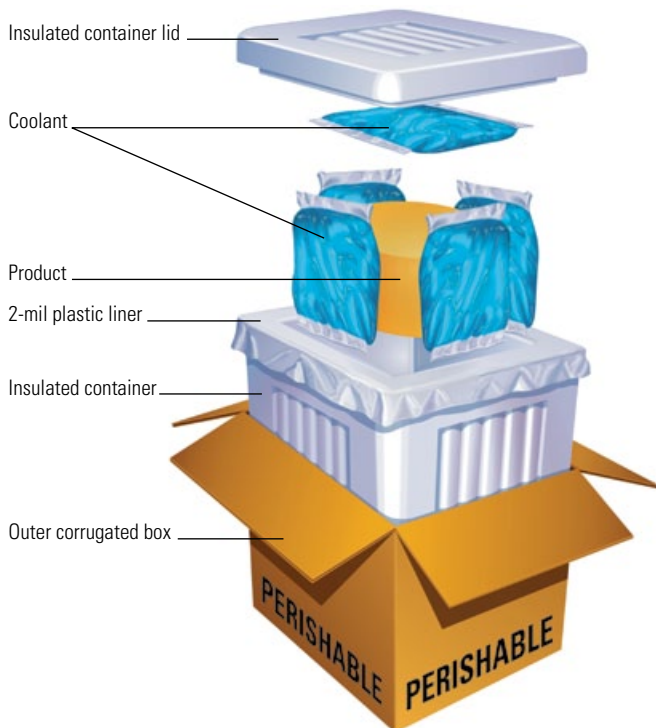

Bag Closure Instructions



Twist end of bag tightly.

Fold over.

Wrap rubber band securely around fold-over to ensure closure.

Packaging Seafood Shipments With Gel Coolants

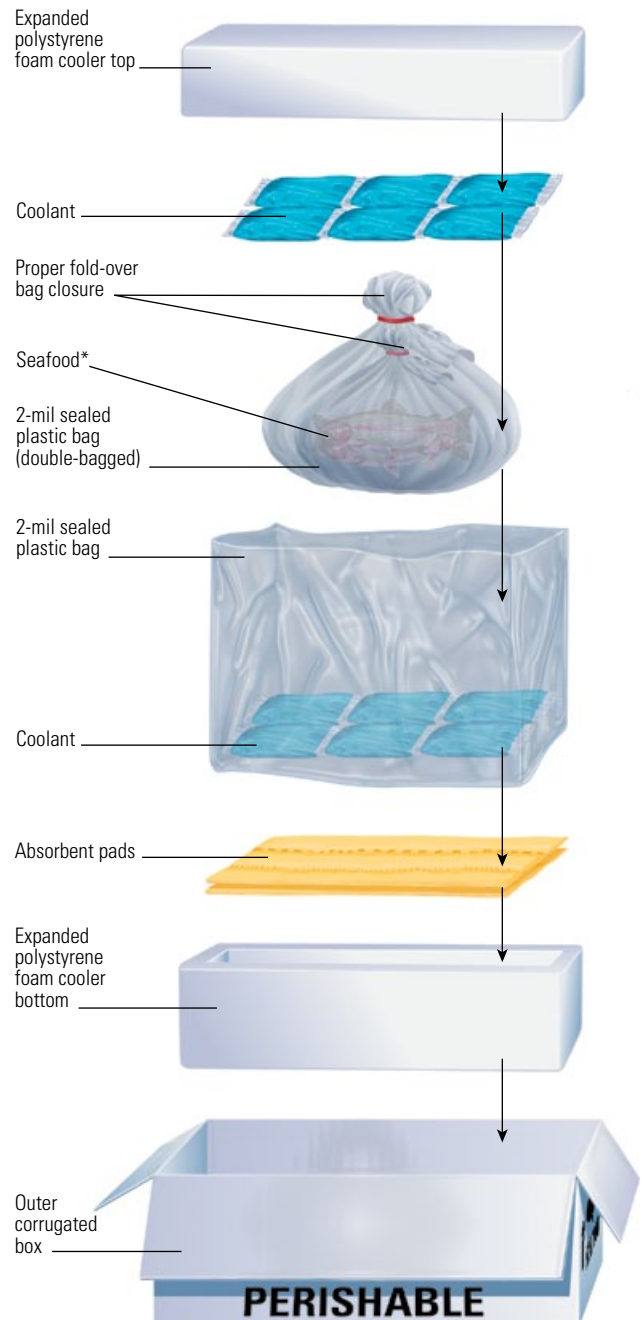

* When shipping live edible seafood (lobsters, oysters, crabs), use gel coolants and follow the same packaging steps except do not seal the bags.

How to Keep Products Frozen During Transit

- Freeze products before packaging.
- Precool the insulated container, if possible.
- If the shipment contains liquid or perishable products that can melt or thaw, bag the products or line the insulated container using a minimum 2-mil watertight plastic bag.
- When arranging products inside the insulated container, allow enough space for dry ice.
- Place a sufficient amount of dry ice in the insulated container on top of and around the products.
- Fill void spaces with dunnage material such as loosefill peanuts.
- Close the liner bag (if used) but do not completely seal it, as the carbon dioxide gas created by the dry ice must be allowed to vent.
- Place the lid on the insulated container.
- Place the insulated container inside an outer corrugated box.
- Close and securely tape the box with pressure-sensitive plastic tape. Apply tape to all flaps and seams.
- Complete the required paperwork, dangerous goods labeling, and markings.

Dry Ice Shipping Regulations

Dry ice (or carbon dioxide solid, UN 1845) is considered a dangerous good/hazardous material for air transport and requires special handling. Shippers are also required to have function-specific dangerous goods training as outlined in 49CFR (Code of Federal Regulations) 172.700.

When dry ice changes to carbon dioxide gas in enclosed spaces like aircraft cargo holds, it displaces oxygen. The design and construction of packaging used for dry ice shipments must prevent the buildup of pressure that could cause rupturing. Dry ice must never be placed in an airtight container.

When shipping with dry ice, you must provide correct identification, classification, markings, and labeling on your outer carton to comply with current requirements in the International Air Transport Association (IATA) dangerous goods regulations.

The following permanent markings are required on the outer packaging of all IATA dry ice shipments:

- "Dry Ice" or "Carbon Dioxide Solid."
- "UN 1845."
- Net weight of dry ice in kilograms.
- Name and address of the shipper.
- Name and address of the recipient.

FedEx Dry Ice Label

The image shows a FedEx Dry Ice Label template. It features a large, downward-pointing triangle with vertical black and white stripes. To the left of the triangle, the text reads "Dry Ice UN 1845" and "Airbills must have the following: 1. Dry Ice; UN 1845 2. (Number pkgs) x (wt) kg." To the right, there are fields for weight: "_____ kg" and "2 lb = 1 kg". Below the triangle, there are fields for "Shipper:" and "Recipient:" with lines for text entry. A large number "9" is centered below the triangle. At the bottom left, the code "106426 9/11 RRD" is visible.

An IATA Class 9 Miscellaneous label must appear on all dry ice shipments. FedEx Express offers a dry ice label that, when correctly completed, satisfies the IATA marking and labeling requirements, available free of charge at fedex.com or by calling 1.800.GoFedEx 1.800.463.3339.

Whether you use online shipment processing at **fedex.com** or a FedEx airbill, select "Dry Ice" on your documentation and complete the dry ice information. In addition, mark "Yes, Shipper's Declaration not required" in the Special Handling section on the airbill.

If you have questions or need more information about dry ice shipments, call the FedEx Dangerous Goods/Hazardous Materials Hotline at 1.800.GoFedEx 1.800.463.3339; press "81" or say "dangerous goods."

Packaging Perishable Shipments With Dry Ice

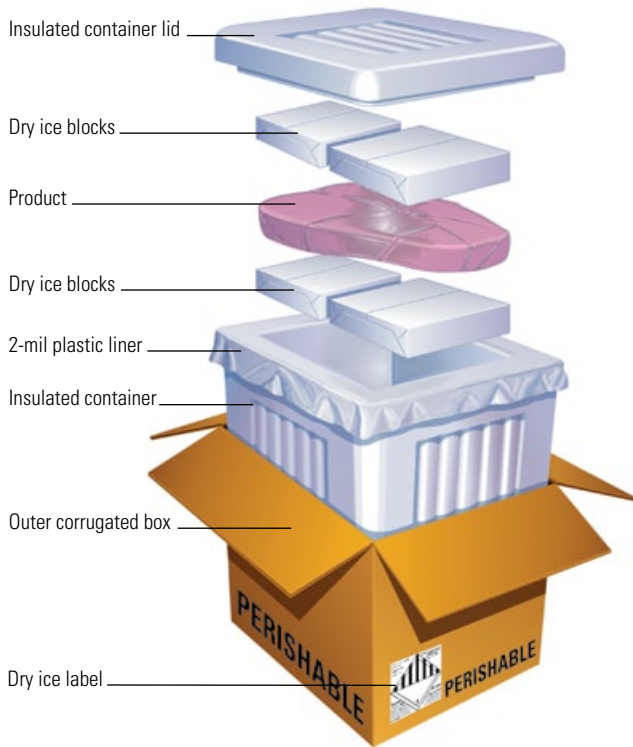

Additional Requirements for Shipping Frozen Seafood

- Double-bag seafood in minimum 2-mil plastic bags, with each bag individually sealed using the fold-over method.
- Place adequate absorbent material such as pads, cellulose wadding, or paper towels in the bottom of the foam container to absorb any liquids.

Packaging Frozen Seafood Shipments With Dry Ice

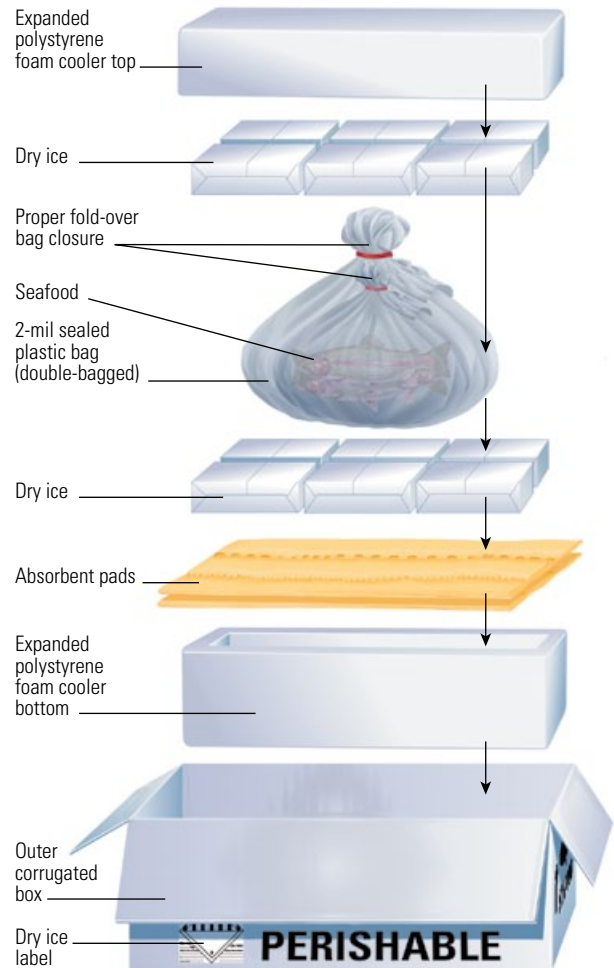

Shipping Seafood With Wet Ice

FedEx does not recommend the use of wet ice (frozen water) as a refrigerant. If you believe wet ice is necessary, it must be prepared to prevent the leakage of any liquid, regardless of orientation.

- Double-bag seafood in minimum 2-mil plastic bags, with each bag individually sealed using the fold-over method.
- Double-bag the ice in minimum 2-mil plastic bags, with each bag individually sealed using the fold-over method.
- Line the insulated container using a minimum 2-mil watertight plastic bag.
- Place adequate absorbent material such as pads, cellulose wadding, or paper towels in the bottom of the foam container to absorb any liquids.
- Follow all other packaging requirements for seafood shipments.
- Ship via FedEx Priority Overnight service only.

Packaging Seafood Shipments With Wet Ice



How to Protect Products From Freezing

You can help protect your products from low temperatures or freezing by using "heat sinks," which help maintain desired temperatures. Gel coolants make good heat sinks.

- Place your products inside an insulated container and surround them with room-temperature (about 72 F) gel coolants to reduce the risk of freezing.
- Fill all void space with dunnage such as loosefill peanuts to prevent product movement.
- Ship the insulated container inside a corrugated box.

Packaging Perishables to Prevent Freezing

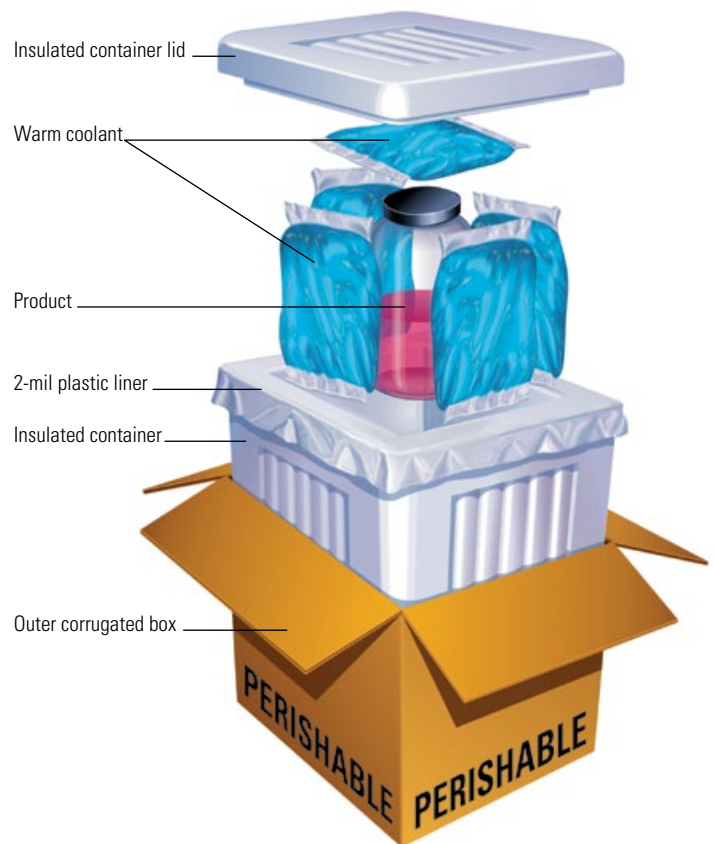

Sealing and Labeling Instructions

- Apply at least three strips of pressure-sensitive adhesive plastic tape that is at least 2" wide to both the top and bottom of the carton.
- Tape all seams or flaps using the H taping method.
- Place the shipping label on the top of the largest surface.
- Mark your outer container "Perishable."

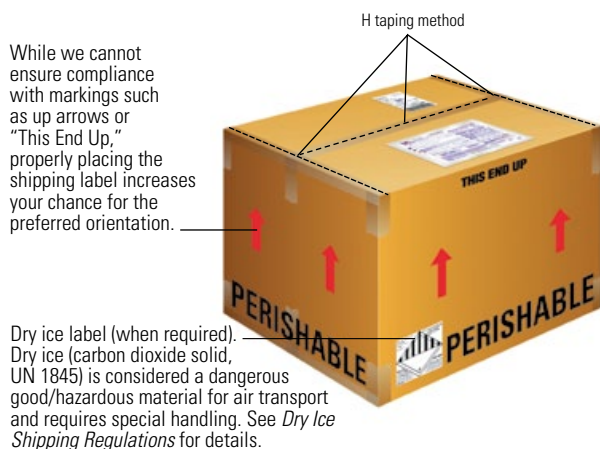

The FedEx Express Transportation Environment

Perishable products must withstand various temperature conditions in the FedEx Express shipping environment.

The cargo areas of our vans and trucks are not temperature-controlled, and temperature will vary depending on time of year, location, exposure to sunlight, and other variables. In summer months the temperature in the cargo area of ground vehicles can be as much as 30 degrees Fahrenheit higher than the ambient temperature outside the vehicle.

On board FedEx Express aircraft, temperatures vary depending on the type of aircraft, the location of each cargo compartment and the package location within each compartment, the length of flight, and the cruising altitude. For general reference, temperatures aboard most wide-body aircraft main cargo compartments vary between 65 F (18 C) and 90 F (32 C). Packages positioned in the bulk department, next to the aircraft's outer structure, might be exposed to temperatures as low as 0 F (-18 C) during flight.

Air pressures on FedEx Express aircraft vary from as low as 8.3 psi at cruise altitude to as much as 14.7 psi on the ground.

FedEx Package Testing and Design Services

We offer free package testing, evaluation, and design services that can help you predict packaging performance and avoid product spoilage. We encourage you to submit a sample of your perishables packaging for testing and evaluation.

Testing Request Guidelines

Follow these steps for submitting your packaging for testing. An active FedEx account number is required. You and your FedEx account executive should expect testing results via email in approximately five to seven business days from FedEx Packaging Services' receipt of your packaging.

1. Obtain a FedEx Packaging Test Application at [fedex.com/packaging](https://www.fedex.com/packaging) or by contacting FedEx Packaging Services at packagingservices@fedex.com or 1.800.633.7019.
2. Complete and sign your application, referencing the name of your FedEx account executive on the form. See the FedEx Packaging Test Application for terms governing test or design.
3. Prepare a sample test package including all the packaging components and contents in the exact configuration you intend to send to your customer.
4. Place your completed application, your sample test package labeled "Test This Package," and any necessary cushioning material in a sturdy outer container marked "Overpacked/Test Pkg. Inside."
5. Send your shipment to the address indicated on the FedEx Packaging Test Application.

Contacts and Resources

- *How to Pack* guidelines at fedex.com/packaging.
- FedEx Packaging Services lab, packagingservices@fedex.com or 1.800.633.7019.
- FedEx field packaging engineers, pkgfield@corp.ds.fedex.com, or contact your FedEx account executive for a referral.
- FedEx Dangerous Goods/Hazardous Materials Hotline, 1.800.GoFedEx 1.800.463.3339; press "81" or say "dangerous goods."

NOTICE: This packaging brochure is provided to FedEx customers to help reduce loss or damage due to improper packaging. It is NOT intended to be a comprehensive guide for packaging items we accept for transit. We make no warranties, expressed or implied, regarding this information. Proper packaging is the sole responsibility of the shipper. For more information and additional guidelines, go to the packaging tips page on fedex.com/packaging, email packagingservices@fedex.com, or contact FedEx Packaging Services at 1.800.633.7019. Refer to the current FedEx Service Guide for terms, conditions, and limitations applicable to FedEx® delivery services.

© 2012 FedEx. All rights reserved.



Packaging Flowers and Plants

To help ensure that your fresh flowers and live plants arrive in top condition, follow these instructions for packaging and shipping via FedEx Express® services.

Contents

Packaging Requirements	18
Preparing Flowers and Plants for Shipment	18
Express Service Recommendations	19
Sealing and Labeling Instructions	20
FedEx Package Testing and Design Services	20
Contacts and Resources	20



Packaging Requirements

Observe the following general requirements when packaging your shipments:

- Secure contents inside the shipping container, because directional arrows cannot always be honored, and plants and flowers may be shipped in different orientations.
- Protect flowers and plants from temperature extremes that may occur during shipment or after delivery at the recipient's location; for climate protection, see the perishables section of the *How to Pack* guidelines at [fedex.com/packaging](https://www.fedex.com/packaging).
- To prevent leaks and spills, ship vases or containers without water and cover soil in pots and plant containers.
- Place your shipping label on the top of the box to increase the chance of shipment in the preferred orientation.
- Make sure your shipments comply with any applicable local, state, and federal laws governing shipment of flowers and plants.

Preparing Flowers and Plants for Shipment

From floral arrangements to bulk flowers, seedlings to mature plants, packaging requirements vary based on the contents of your shipment. The instructions and illustrations are provided here to help you develop effective packaging for your shipments.

Floral Arrangements

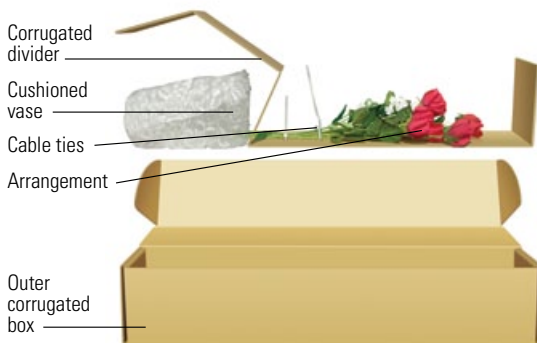

Secure floral arrangements inside a box using cable ties or bands secured to the box or to an inside insert to prevent shifting of the arrangement during shipment. If you are shipping a vase with the arrangement, also secure the vase inside the box. We recommend a corrugated divider to separate the vase from the flowers. If the vase is fragile,

use additional packaging materials to cushion the vase and protect it from damage during shipment. Ship vases or containers without water; shipping with water is prohibited because it may leak during shipment and cause product damage or safety issues.

Plant Seedlings and Plugs

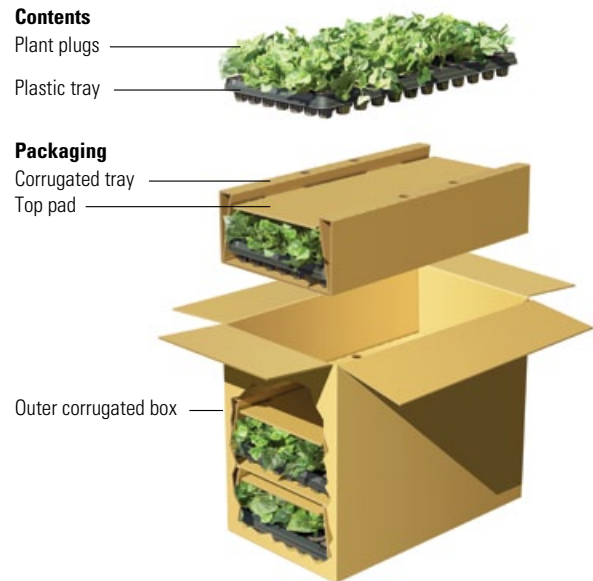

Plant seedlings and plugs are fragile and difficult to secure in the shipping carton, so they require special attention. We recommend a corrugated tray with a top pad designed to push lightly against seedlings or plugs to secure them in their plastic tray during shipment. This packaging method works best with leafy seedlings and plugs, not tall and spindly plant material. You can use plastic mesh over the plant plugs to provide added security. The moisture content of the soil is also an important consideration during shipment. If the soil is too dry, plugs are more likely to spill out of the plastic tray. If the soil is too wet, the corrugated tray may weaken from the moisture. Since you cannot secure plant plugs individually inside the plastic tray, you can expect some plugs to be dislodged during transit and some soil to sift out of the plastic tray, so plan accordingly when preparing your shipment.

Plants

When shipping plants, secure them to prevent movement inside the shipping carton. If the plant shifts inside the carton, it can cause breakage of plant stems and leaves, so we recommend using a corrugated divider that locks the pot inside the box. The soil inside the box must also be contained. Place the pot in a plastic bag and secure the top opening of the bag around the stem of the plant. If the plant does not have a single main stem, you can place paper between the leaves and over the soil and secure it to the pot.

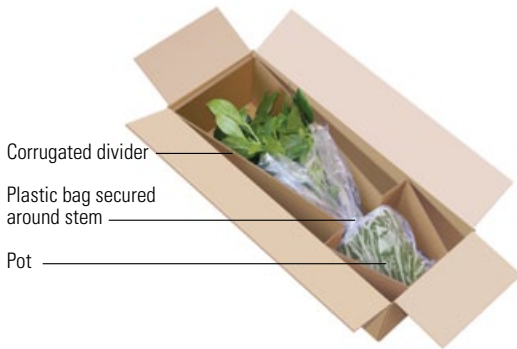

Orchids

Orchids require special packing because they are inherently fragile. When shipping multiple orchids, secure the pots in the shipping carton with enough space to keep plants separated during shipment. Contact between the plants' blooms and leaves can lead to damage. You can also wrap the blooms and leaves in paper to provide extra cushioning when shipping. Cold temperatures can be harmful to tropical flowers like orchids, so when shipping to cold climates make sure your packaging is designed to protect the flowers from temperature variations during shipment.

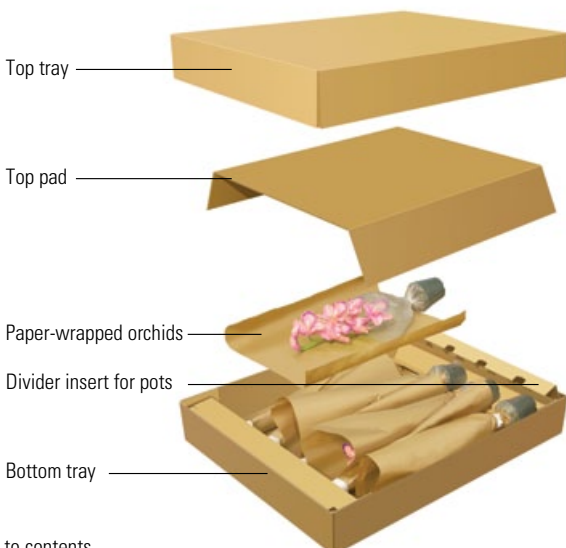

Bulk Flower Shipments

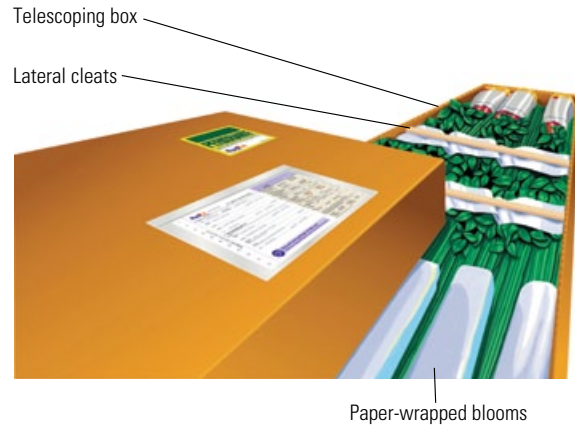

Place bulk flowers in telescoping boxes that accommodate the size of your plant material. Ideally, the boxes should measure less than 38" in length, 24" in height and 26" in width. Use lateral cleats or bands to prevent shifting of the flowers inside the box. Choose corrugated shipping cartons constructed with moisture-resistant adhesive, because when the box is precooled, temperature and humidity can weaken it. We recommend that you use tape to secure the box. Straps can be used, but they tend to loosen during shipment and may compromise the closure of the box. Do not use string or twine to secure the box.

Express Service Recommendations

- Like other perishables, we recommend that flowers and plants be shipped via FedEx First Overnight[®], FedEx Priority Overnight[®], FedEx Standard Overnight[®], or FedEx 1Day[®] Freight.
- The maximum acceptable gross weight per package for most FedEx Express overnight services is 150 lbs., including packaging and refrigerant.
- For overnight shipment of packages with a gross weight of 151 to 2,200 lbs. each, use FedEx 1Day Freight.
- We recommend that you package flowers and plants for a minimum transit time of 30 hours.
- FedEx does not recommend shipping perishables like flowers and plants via FedEx 2Day[®], FedEx 2Day[®] Freight, or FedEx Express Saver[®], but if you choose to, you should package shipments for at least 12 hours more than the delivery commitment time.
- Avoid shipment of perishable items on days that will require transit on a weekend or over a holiday period.

Sealing and Labeling Instructions

- Apply at least three strips of pressure-sensitive adhesive plastic tape that is at least 2" wide to both the top and bottom of the carton.
- Tape all seams or flaps using the H taping method.
- Place the shipping label on the top of the largest surface.

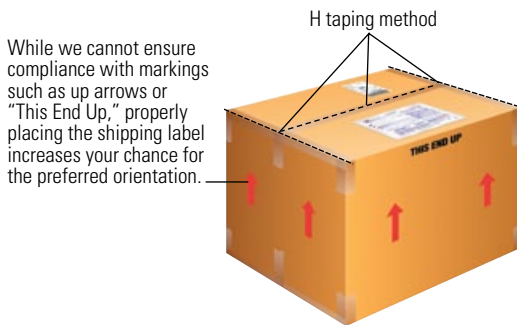

FedEx Package Testing and Design Services

We offer package testing, evaluation, and design services that can help you predict packaging performance. Packaging must be tested for acceptance by FedEx Packaging Services prior to shipping. Submit a sample of your flower or plant packaging for testing and evaluation.

Testing Request Guidelines

Follow these steps for submitting your packaging for testing. An active FedEx account number is required. You and your FedEx account executive should expect testing results via email in approximately five to seven business days from FedEx Packaging Services' receipt of your packaging.

1. Obtain a FedEx Packaging Test Application at **fedex.com/packaging** or by contacting FedEx Packaging Services at packagingservices@fedex.com or 1.800.633.7019.
2. Complete and sign your application, referencing the name of your FedEx account executive on the form.

3. Prepare a sample test package including all the packaging components and contents in the exact configuration you intend to send to your customer.
4. Place your completed application, your sample test package labeled "Test This Package," and any necessary cushioning material in a sturdy outer container marked "Overpacked/Test Pkg. Inside."
5. Send your shipment to the address indicated on the FedEx Packaging Test Application.

Contacts and Resources

- See the perishables section of the *How to Pack* guidelines at **fedex.com/packaging**.
- FedEx Packaging Services lab, packagingservices@fedex.com or 1.800.633.7019.
- FedEx field packaging engineers, pkgfield@corp.ds.fedex.com, or contact your FedEx account executive for a referral.

NOTICE: This packaging brochure is provided to FedEx customers to help reduce loss or damage due to improper packaging. It is NOT intended to be a comprehensive guide for packaging items we accept for transit. We make no warranties, expressed or implied, regarding this information. Proper packaging is the sole responsibility of the shipper. For more information and additional guidelines, go to the packaging tips page on **fedex.com/packaging**, email packagingservices@fedex.com, or contact FedEx Packaging Services at 1.800.633.7019. Refer to the current FedEx Service Guide for terms, conditions, and limitations applicable to FedEx® delivery services.
© 2012 FedEx. All rights reserved.



Packaging Computer Shipments

To help protect your computers and peripherals from shock and vibration during transit, follow these instructions for shipping via FedEx® services.

Contents

Recommended Packaging Options	22
Shipping With Original Manufacturer’s Packaging	22
Shipping Without Original Manufacturer’s Packaging	22
Sealing and Labeling Instructions	24
Shipping in a FedEx Laptop Box	24
Shipping in a Transit Case	24
Packaging Freight Shipments	25
General Guidelines for Shipping Computer Parts and Peripherals	25
FedEx Package Testing and Design Services	26
Contacts and Resources	26



Recommended Packaging Options

This brochure will help you pack and prepare your computer and peripheral shipments. Follow the instructions for the packaging method of your choice.

- Shipping with original manufacturer's packaging.
- Shipping without original manufacturer's packaging.
- Shipping in a FedEx Laptop Box.
- Shipping in a transit case.
- Packaging freight shipments.

Shipping With Original Manufacturer's Packaging

Original packaging is usually designed to ship the product once, not multiple times. Reuse can weaken the packaging and place the inside product at risk. Overboxing provides extra integrity for the weakened original manufacturer's packaging.

Using Original Packaging and an Outer Box

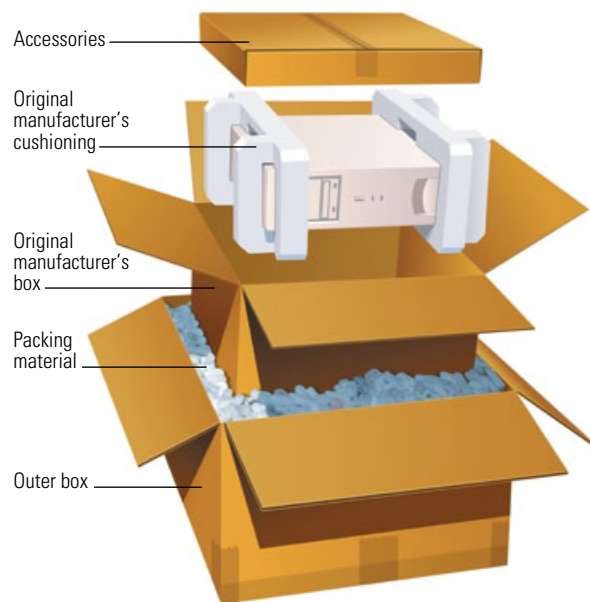

Inspect the original packaging to ensure that the cushioning material and box are intact and unbroken. Make any repairs with pressure-sensitive adhesive plastic tape that is at least 2" wide. Pack the product using all the original packaging components.

Obtain a box that is at least 6" larger in length, width, and height than the original manufacturer's packaging. Fill the bottom of the box with 3" of packing material (e.g., air-cellular cushioning material such as Bubble Wrap® or loosefill peanuts). Do not use crushed paper. Center the original manufacturer's packaging inside the outer box and fill empty spaces on all sides and the top with packing material. The inner box should be surrounded with at least 3" of packing material around all six sides of the inner box.

Apply at least three strips of pressure-sensitive adhesive plastic tape that is at least 2" wide to both the top and bottom of the carton to protect the package and its contents. Tape all seams or flaps.

Shipping Without Original Manufacturer's Packaging

We recommend three methods for shipping your computers and peripherals if you don't have, or prefer not to use, the original manufacturer's packaging.



Using Air-Cellular Cushioning Material

Wrap the computer or peripheral on all sides with at least 3" to 4" of air-cellular cushioning material. Place the wrapped item inside a sturdy outer box. Accessories that are wrapped in appropriate amounts of cushioning can also be placed in any open spaces of the box. Fill all spaces with additional cushioning so that the wrapped item fits tightly inside the box. If no open spaces exist, pack accessories in an additional box.

Close and seal both the top and bottom of the box with three strips of pressure-sensitive plastic tape that is at least 2" wide. Tape all seams or flaps.

Using Loosefill Peanuts

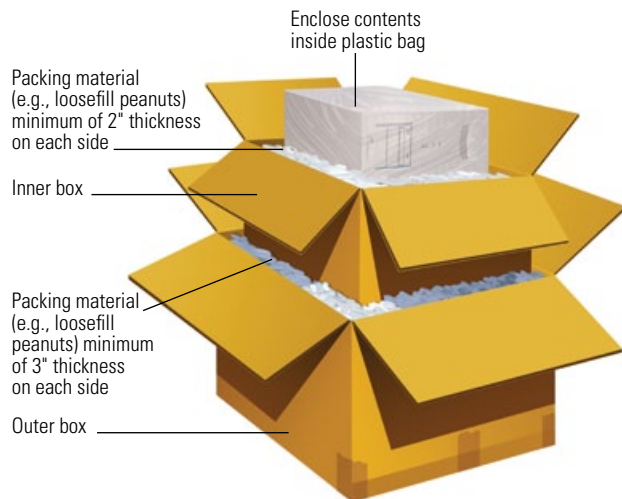

Since this type of packing material allows the packaged item to settle to the bottom of the box, it is important to use the overbox method of packaging. The inner box should be at least 4" greater in length, width, and height than the item you are shipping. This will allow for 2" of space for all six sides. The outer box should be at least 6" greater in length, width, and height than the inner box. This will allow 3" of space between the inner box and the outer box.

Wrap the computer or peripheral in a plastic bag to prevent the loosefill peanuts from getting inside the unit. Fill the bottom of the inner box with at least 2" of loosefill peanuts and center the wrapped item inside the box. Fill empty spaces on all sides and top with loosefill peanuts, ensuring that there is at least 2" of loosefill peanuts on all six sides of the item. Pack accessories such as power cords, keyboards, and external drives separately, away from the computer or peripheral.

Close and seal both the top and bottom of the box with three strips of pressure-sensitive plastic tape that is at least 2" wide.

Fill the bottom of the outer box with at least 3" of loosefill peanuts and center the inner box inside the outer box. Fill empty spaces on all sides and top of the inner box with loosefill peanuts, ensuring that there is at least 3" of loosefill peanuts on all six sides.

Close and seal both the top and bottom of the box with three strips of pressure-sensitive plastic tape that is at least 2" wide. Tape all seams or flaps.

Using Foam Corner Cushioning

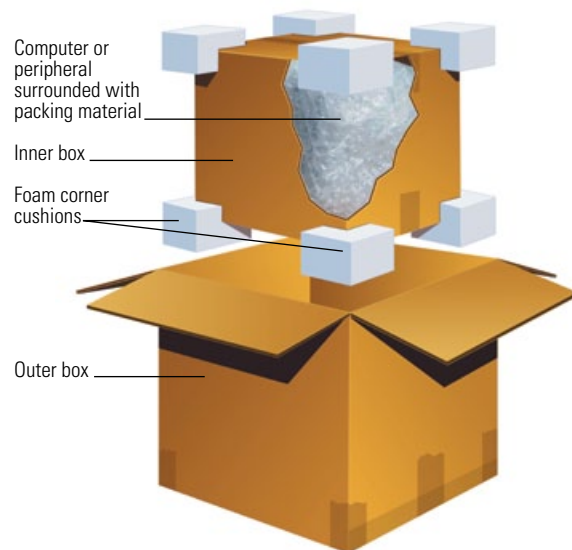

You may choose to use foam corner cushioning specifically designed to properly cushion your product during shipping. This packing method allows you to use one size of inner box, one size of outer box, and one type of foam corner cushioning to ship items of various sizes and weights.

Place the computer or peripheral inside the box and surround the item with at least 1-1/2" of packing material (e.g., loosefill peanuts, air-cellular cushioning, foam-in-place) on all sides so that the item does not move inside the box.

Close and seal the top and bottom of the inner box with three strips of pressure-sensitive plastic tape that is at least 2" wide.

Place the box containing the item inside a larger (outer) box fitted with the foam corner cushions. The outer box must fit tightly around the foam corner cushions.

Close and seal the top and bottom of the outer box with three strips of pressure-sensitive plastic tape that is at least 2" wide. Tape all seams or flaps.

Sealing and Labeling Instructions

- Using the H taping method, apply at least three strips of pressure-sensitive adhesive plastic tape that is at least 2" wide to both the top and bottom of the carton.
- Tape all seams or flaps.
- Place the shipping label on the top of the largest side.

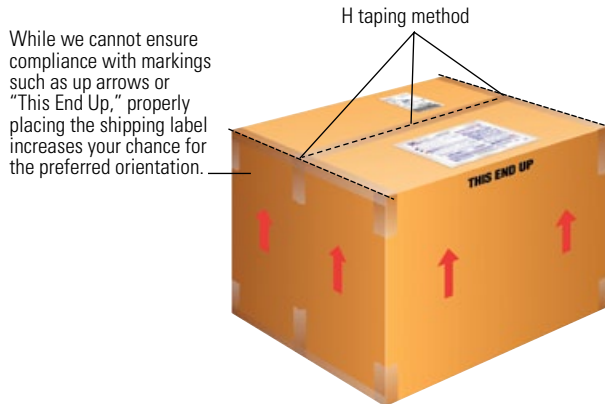

Shipping in a FedEx Laptop Box

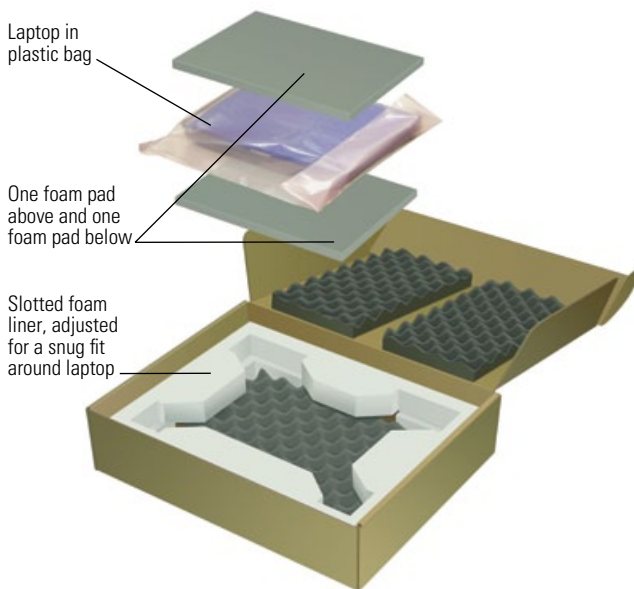

When shipping a laptop computer, we recommend that you use our specially designed FedEx Laptop Box whenever possible. The box includes cushioning material and is available for purchase at FedEx Office and FedEx World Service Center® locations.

Place the laptop in the plastic bag, then place one foam pad above and one foam pad below the wrapped laptop. Adjust the slotted foam liner by tearing off just enough material to ensure a snug fit around the laptop. Close the box by inserting the flaps into the side walls. Seal the bottom edge of the laptop box with a strip of pressure-sensitive plastic tape that is at least 2" wide.

Shipping in a Transit Case

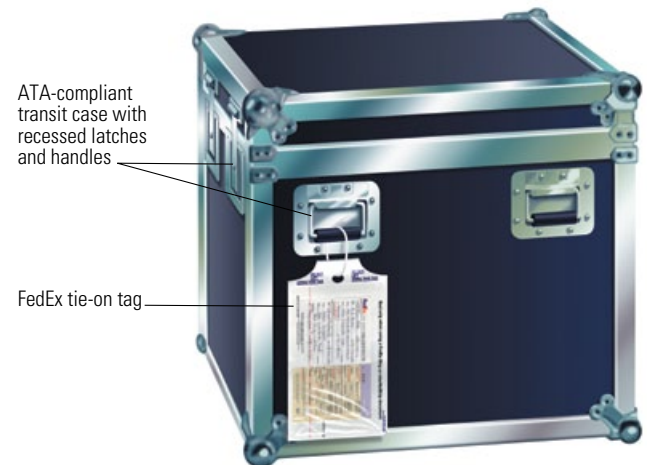

While transit cases can effectively protect computers and peripherals that will be shipped multiple times, care must be taken in the design of both the outer case and the inner cushioning.

When selecting a transit case, make sure the inner foam cushioning is designed to the proper fragility level to protect the computer or peripheral during shipping. Also make sure the outer case is manufactured in compliance with Airline Transport Association (ATA) standards. Handles, latches, wheels, and locks should be recessed into the case. Replace the foam cushioning inside the case periodically, because with use, the cushioning will break down and no longer provide proper protection for the product.

Attach the shipping label using a FedEx tie-on tag, available at [fedex.com](https://www.fedex.com) or by calling 1.800.GoFedEx 1.800.463.3339.

Packaging Freight Shipments

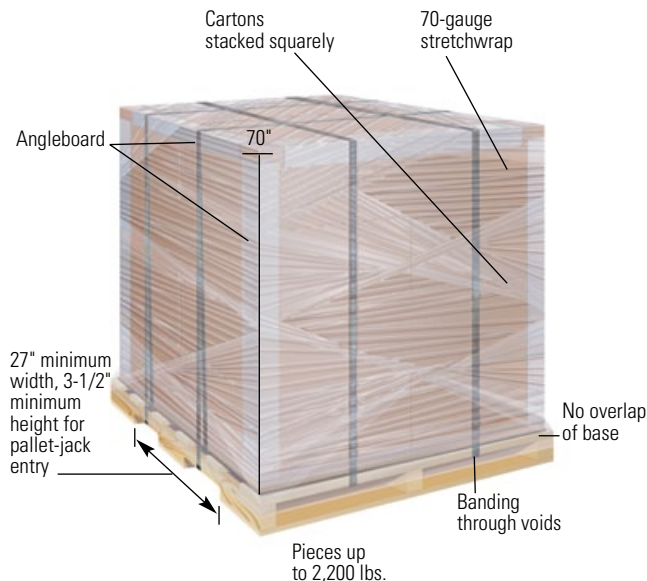

Shipments that qualify as freight must be packaged accordingly. See the current FedEx Service Guide to determine if your shipment qualifies as freight.

For detailed information on preparing freight shipments, refer to *Packaging Guidelines for Shipping Freight* at [fedex.com/packaging](https://www.fedex.com/packaging).

You must package your freight shipments to allow for stacking of other packages on top of your shipment. Make sure your freight shipments are banded and stretchwrapped to the pallet, with the bands running in both directions. (Pallet loads secured with only stretch-wrap are not acceptable.)

Avoid corrugated or fiberboard pallets. You must secure all freight shipments weighing 151 lbs. or more on a forkliftable base, compatible with pallet-jack usage. The minimum specifications for a typical base for forklift or pallet-jack configuration are illustrated above.

Express Freight Shipments

To lessen the possibility of damage or delay to your cargo, make sure that all single-piece cargo greater than 150 lbs. is banded on all sides with heavy-duty metal or break-resistant plastic banding.

If your cargo is a single piece contained within a hardened container (plywood, metal) and is greater than 150 lbs., it does not require banding if exterior locks or clamps are used. (Glue, nails, or screws are not sufficient.)

General Guidelines for Shipping Computer Parts and Peripherals

Whichever packaging method you use, you'll find the following tips helpful when packing specific items.

Monitors

Remove the base and any attachments from the monitor when possible. Ship the monitor face-down.

Printers

Remove printing cartridges before shipping, and place cartridges inside a sealed plastic bag to prevent ink or powder from leaking into the box. Tape moving parts such as doors and print heads to secure them during transit. Remove any paper trays and pack them separately.

Scanners

Most manufacturers recommend that you secure the scanner carriage to prevent movement when shipping. Refer to your owner's manual for more information.

Computer Housings With or Without Internal Components

Packaging designed for computer housings without internal components is usually designed for the weight of the empty housing. If you assemble and install inner components (such as circuit boards and disk drives), make sure your packaging can accommodate the increased weight. For security reasons, you may want to encrypt or remove any confidential data stored on the computer before shipping. Overbox shipments of assembled units in original packaging.

Data Storage Devices

Before shipping CDs, memory sticks, magnetic tapes, or other data storage media, you should back up any data stored on the devices. For security reasons, you may also want to remove or encrypt any sensitive personal, confidential, or financial information. FedEx liability for loss of any electronic data is limited only to the cost of the medium on which the data is stored. See Liabilities Not Assumed in the current FedEx Service Guide.

Servers, Routers, Large Laser Printers

Due to the high value and variable weights and sizes of these units, we recommend that customers contact FedEx Packaging Services for packaging recommendations.

FedEx Package Testing and Design Services

We offer free package testing, evaluation, and design services that can help you avoid product damage. In some cases, we may even help you eliminate unnecessary packaging costs. We encourage you to submit a sample of your packaging for testing and evaluation. For a copy of our test procedures go to fedex.com/packaging or contact FedEx Packaging Services.

Testing Request Guidelines

Follow these steps for submitting your packaging for testing. An active FedEx account number is required. You and your FedEx account executive should expect testing results via email in approximately five to seven business days from FedEx Packaging Services' receipt of your packaging.

1. Obtain a FedEx Packaging Test Application at fedex.com/packaging or by contacting FedEx Packaging Services at packagingservices@fedex.com or 1.800.633.7019.

2. Complete and sign your application, referencing the name of your FedEx account executive on the form. See the FedEx Packaging Test Application for terms governing testing or design.
3. Prepare a sample test package including all the packaging components and contents in the exact configuration you intend to send to your customer.
4. Place your completed application, your sample test package labeled "Test This Package," and any necessary cushioning material in a sturdy outer container marked "Overpacked/Test Pkg. Inside."
5. Send your shipment to the address indicated on the FedEx Packaging Test Application.

Custom-Designed Packaging

If you ship computers and peripherals frequently, you may also want to have your packaging custom designed. FedEx Packaging Services can provide guidance to you and your packaging supplier. For example, you may be interested in a customized foam cushion specifically designed to fit and protect your fragile computer and to pass all FedEx packaging tests. Our packaging engineers can help with your custom designs.

Contacts and Resources

- *How to Pack* guidelines at fedex.com/packaging.
- FedEx Packaging Design and Development lab, packagingservices@fedex.com or 1.800.633.7019.
- FedEx field packaging engineers, pkgfield@corp.ds.fedex.com, or contact your FedEx account executive for a referral.

Bubble Wrap is a registered trademark of Sealed Air Corporation.

NOTICE: This packaging brochure is provided to FedEx customers to help reduce loss or damage due to improper packaging. It is NOT intended to be a comprehensive guide for packaging items we accept for transit. We make no warranties, expressed or implied, regarding this information. Proper packaging is the sole responsibility of the shipper. For more information and additional guidelines, go to the packaging tips page on fedex.com/packaging, email packagingservices@fedex.com, or contact FedEx Packaging Services at 1.800.633.7019. Refer to the current FedEx Service Guide for terms, conditions, and limitations applicable to FedEx® delivery services.

© 2012 FedEx. All rights reserved.



Packaging Clinical Samples

Follow these instructions for packaging, marking, and labeling clinical samples for shipment via FedEx Express® services.

Contents

Requirements for Clinical Samples	28
General Packaging Requirements	28
Additional Packaging Requirements for Non-Infectious Clinical Samples	29
FedEx Clinical Packaging Options	29
FedEx Package Evaluation Services	30
Contacts and Resources	30



Requirements for Clinical Samples

This guide outlines the requirements for shipping with FedEx Express. In addition, all shipments must comply with all applicable local, state, and federal laws governing packing, marking, and labeling. Blood, urine, fluids, and other specimens containing or suspected of containing infectious substances must be shipped according to applicable government, International Air Transport Association (IATA), and International Civil Aviation Organization (ICAO) regulations.

For the purposes of this guide, clinical samples are generally defined as non-infectious human or animal materials including, but not limited to, excreta, secretions, tissue and tissue fluids, blood, and FDA-approved pharmaceuticals that are blood products.

General Packaging Requirements

For liquid clinical samples, you must include four layers of packaging:

- 1. Primary watertight inner receptacle.** Use watertight containers for liquid specimens with a positive closure such as a screw-on, snap-on, or push-on lid, taped for an additional seal. If you place multiple fragile primary receptacles in a single secondary receptacle, they must be individually wrapped or separated to prevent contact between them.
- 2. Absorbent material.** Place absorbent material between the primary and secondary receptacles, using enough material to absorb the entire contents of all primary receptacles. Acceptable absorbent materials include cellulose wadding, cotton balls, super-absorbent packets, and paper towels.
- 3. Secondary watertight inner receptacle.** Use a watertight sealed plastic bag, plastic canister, or screw-cap can.
- 4. Sturdy outer packaging.** Use rigid outer packaging constructed of corrugated fiberboard, wood, metal, plastic, or other equally strong material, including cylinders made of such materials and appropriately sized for the contents. Chipboard or paperboard boxes are unacceptable outer packaging. The completed packaging must be of good quality, strong enough to withstand the normal rigors of transportation without loss of contents as a result of vibration, changes in temperature, humidity, or pressure.

Acceptable Primary Watertight Receptacles

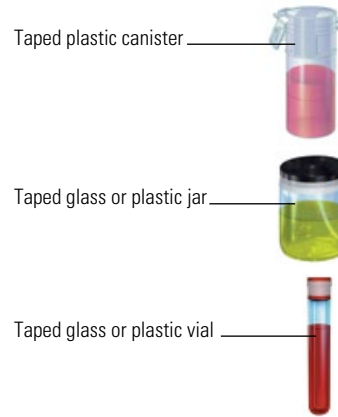

Acceptable Absorbent Materials

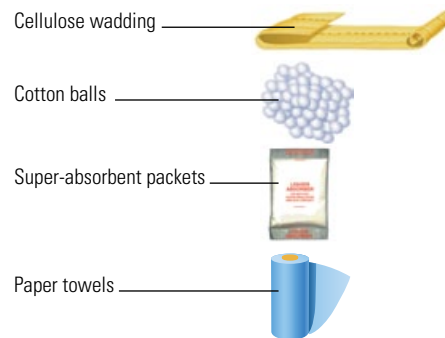

Acceptable Secondary Watertight Receptacles



Additional Packaging Requirements for Non-Infectious Clinical Samples

To ensure safe delivery of your clinical sample shipments, we provide these additional guidelines.

Liquid Clinical Sample Marking Requirements

Include a marking on the package that properly identifies the shipment as “Exempt Human Specimen” or “Exempt Animal Specimen” as appropriate to comply with current IATA and ICAO regulations. If you prefer, package markings may be in the form of a label.

Dried Samples

While non-infectious samples of dried blood, tissue, saliva, and hair are not dangerous goods and are not required to meet dangerous goods regulations, they do require special packaging that meets FedEx Express guidelines. Dried samples, including but not limited to hair, swabs, or dried blood, must be placed into a sealed paper or plastic envelope and then into a 6" x 8" or larger mailing envelope or pak. Samples on glass or plastic slides must be cushioned and packaged in a sturdy outer container.

Note: If the dried sample is placed in a receptacle with a liquid preservative, then the minimum packaging standards for liquids must be followed.

FedEx Clinical Packaging Options

For your convenience, we offer the FedEx® Clinical Pak, the FedEx® Medium Clinical Box, and the FedEx® Large Clinical Box as packaging options for exempt clinical-sample shipments. We recommend the FedEx Clinical Pak for use when the sturdy outer packaging of your properly packaged shipment is smaller than 7" x 4" x 2" (minimum acceptable size).

To help ensure the timely delivery of your shipment and the safety of shipments exposed to yours, our clinical paks and boxes help your clinical shipments stand apart from other shipments. Previous FedEx Clinical Paks were made of plastics with a resin identification code of “7.” If you still have unused paks with this identification code, contact your local municipality to determine the best way to recycle any unused packaging.

To order the FedEx Clinical Pak, go to [fedex.com](https://www.fedex.com) or call 1.800.GoFedEx 1.800.463.3339.

FedEx Clinical Pak



FedEx Medium Clinical Box, FedEx Large Clinical Box



Packaging Restrictions for Clinical Paks and Boxes

- Plastic bags and paper envelopes are unacceptable outer containers.
- The FedEx Clinical Pak is an overwrap primarily designed for easy identification and to handle smaller completed packages. The general packaging requirements outlined on page 28 must be met.
- The FedEx® Envelope, FedEx® Tube, FedEx Pak®, FedEx® Padded Pak, FedEx® UN 3373 Pak, and FedEx boxes (other than FedEx clinical boxes), including FedEx brown packaging offered at FedEx shipping locations, are not acceptable as outer containers for clinical samples.
- The FedEx Clinical Pak can only be used to ship clinical samples. If you need an overwrap for shipments containing Biological Substance, Category B (UN 3373) materials, use the FedEx UN 3373 Pak and package your shipments according to IATA and ICAO regulations.
- The FedEx Clinical Pak must not be used to ship dried samples unless the dried samples are packaged following the requirements for liquid samples.

- Shipments marked or labeled 6.2 (infectious materials) and shipments containing dry ice cannot be shipped in a FedEx Clinical Pak.

If you have questions about whether your shipments require a biohazard label, consult the Occupational Safety and Health Administration (OSHA) for the applicable regulations.

NOTE: You may drop off properly packaged liquid clinical samples in most FedEx Express drop boxes in the U.S. and Puerto Rico.

- FedEx Office® Print and Ship Center locations accept FedEx clinical shipments that are not classified as Biological Substance, Category B (UN 3373).
- FedEx World Service Center® locations accept non-infectious clinical shipments, as well as shipments classified as Biological Substance, Category B (UN 3373).
- FedEx Authorized ShipCenter® locations and FedEx ShipSite® (OfficeMax) locations do not accept clinical or UN 3373 shipments.

For more information, go to fedex.com or call 1.800.GoFedEx 1.800.463.3339 to be directed to a FedEx location equipped to handle these shipments.

FedEx Package Evaluation Services

We offer free package evaluation services, and we encourage you to submit a sample of your clinical packaging for evaluation.

Clinical Packaging Evaluation Request Guidelines

Follow these steps for submitting your packaging for evaluation. An active FedEx account number is required. You and your FedEx account executive should expect evaluation results via email in approximately five to seven business days from FedEx Packaging Services' receipt of your packaging.

1. Obtain a FedEx Packaging Test Application at fedex.com/packaging or by contacting FedEx

Packaging Services at packagingservices@fedex.com or 1.800.633.7019.

2. Complete and sign your application, referencing the name of your FedEx account executive on the form.
3. Prepare a sample package including all the components in the exact configuration you intend to ship. Do not include any specimen(s). Indicate "Non-Hazardous Content" on the samples and on the sample outer box.
4. Place your completed application, any pertinent product documentation, and your sample clinical package labeled "Evaluate This Package" along with any necessary cushioning material in a sturdy outer container marked "Overpacked/Clinical Sample Inside."
5. Send your shipment to the address indicated on the FedEx Packaging Test Application.

Contacts and Resources

- *How to Pack* guidelines at fedex.com/packaging.
- FedEx Dangerous Goods/Hazardous Materials Hotline, 1.800.GoFedEx 1.800.463.3339; press "81" or say "dangerous goods."
- FedEx Dangerous Goods seminars and job aid at fedex.com/us/service-guide/our-services/dangerous-goods-hazmat/index.html.

NOTICE:

FedEx Express will refuse to accept packages that do not meet FedEx Express, government, or IATA and ICAO requirements. This brochure is in no way intended to replace requirements mandated by 49CFR and IATA. This is for informational purposes only.

Tyvek is a registered trademark of E.I. Du Pont De Nemours and Company.

NOTICE: This packaging brochure is provided to FedEx customers to help reduce loss or damage due to improper packaging. It is NOT intended to be a comprehensive guide for packaging items we accept for transit. We make no warranties, expressed or implied, regarding this information. Proper packaging is the sole responsibility of the shipper. For more information and comprehensive guidelines, contact the FedEx Dangerous Goods/Hazardous Materials Hotline at 1.800.GoFedEx 1.800.463.3339; press "81" or say "dangerous goods." (Outside the U.S., request to speak to a dangerous goods representative.) Refer to the current FedEx Service Guide for terms, conditions, and limitations applicable to FedEx® delivery services.

© 2012 FedEx. All rights reserved.

Packaging UN 3373 Shipments

Follow these instructions for packaging, marking, and labeling Biological Substance, Category B (UN 3373) shipments for FedEx Express® services.

Contents

Requirements for Biological Substance, Category B (UN 3373) Shipments	32
General Packaging Requirements	32
Biological Substance, Category B (UN 3373) Marking Requirements	33
FedEx® UN 3373 Packaging Options	33
FedEx Packaging Services	34
Contacts and Resources	34

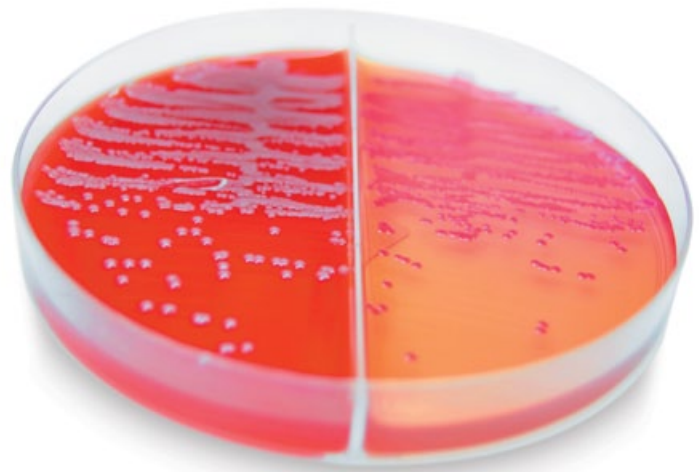

Requirements for Biological Substance, Category B (UN 3373) Shipments

This guide outlines the requirements for shipping with FedEx Express. In addition, all shipments must comply with all applicable local, state, and federal laws governing packing, marking, and labeling. Blood, urine, fluids, and other specimens containing or suspected of containing infectious substances must be shipped according to applicable government, International Air Transport Association (IATA), and International Civil Aviation Organization (ICAO) regulations.

Customers who ship Biological Substance, Category B (UN 3373) shipments must comply with local, state, and federal laws governing identification, classification, packaging, and package markings (which may be in label form). FedEx Express strictly adheres to the IATA, ICAO, and U.S. government guidelines for materials categorized as Biological Substance, Category B (UN 3373).

General Packaging Requirements

For Biological Substance, Category B (UN 3373) shipments, cushioning material is required for both liquid and dried specimens. You must also include four layers of packaging:

- 1. Primary watertight inner receptacle.** Use primary receptacles made of glass, metal, or plastic with a positive means of ensuring a leakproof seal; a skirted stopper or metal crimp seal must be provided; screw caps must be reinforced with adhesive tape. For liquid specimens, the primary receptacle must not contain more than 1 L. For dried specimens, the primary receptacle must not exceed the outer packaging weight limit.
- 2. Absorbent material.** Place absorbent material between the primary and secondary receptacles, using enough material to absorb the entire contents of all primary receptacles. Absorbent material is required for Biological Substance, Category B (UN 3373) shipments containing liquids. Acceptable absorbent materials include cellulose wadding, cotton balls, super-absorbent packets, and paper towels.
- 3. Secondary watertight inner receptacle.** Use a secondary container that is leakproof for liquid specimens or siftproof for dried specimens. Choose only secondary containers certified by the manufacturer for Biological Substance, Category B (UN 3373) prior to use. Either your primary or secondary receptacle must be able to

withstand, without leakage, an internal pressure differential of not less than 95 kPa in the range of -40 C to 55 C (-40 F to 130 F). To prevent contact between multiple fragile primary receptacles, individually wrap or separate them inside the secondary container.

- 4. Sturdy outer packaging.** Use rigid outer packaging constructed of corrugated fiberboard, wood, metal, or plastic, or other equally strong material, including cylinders made of such materials and appropriately sized for the contents. Chipboard or paperboard boxes are unacceptable outer packaging. The completed packaging must be of good quality, strong enough to withstand the normal rigors of transportation without loss of contents as a result of vibration, changes in temperature, humidity, or pressure. Limit the total volume for liquid samples to 4 L and the total weight of dried samples to 4 kg per outer container. At least one surface of the outer packaging must have a minimum dimension of 100 mm x 100 mm (4" x 4"). Completed packages must be able to withstand a 4' (1.2-m) impact test as outlined in IATA 6.6.1 regulations. Before sealing the outer packaging, you must make an itemized list of the contents of the package and enclose the list between the secondary packaging and outer packaging.

Acceptable Primary Receptacles

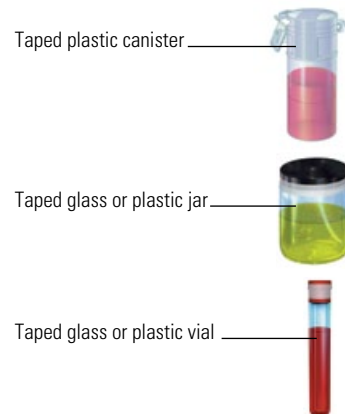

Acceptable Absorbent Materials

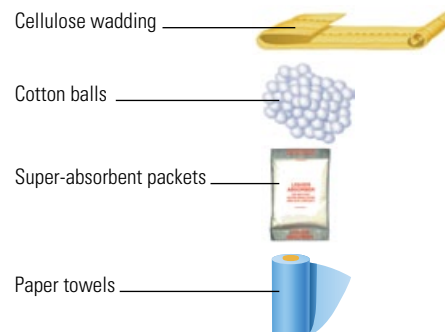

Acceptable Secondary Receptacles



Biological Substance, Category B (UN 3373) Marking Requirements

- Clearly mark “Biological Substance, Category B” in 6-mm-high text on the outer package adjacent to a properly sized UN 3373 diamond-shaped marking. If you prefer, package markings may be in the form of a label.
- If you use the FedEx® Medium Clinical Box or the FedEx® Large Clinical Box to ship samples classified as Biological Substance, Category B (UN 3373), you must add a properly sized UN 3373 diamond-shaped marking. If you prefer, package markings may be in the form of a label.
- If you use the FedEx® UN 3373 Pak, FedEx Medium Clinical Box, or FedEx Large Clinical Box, duplicate all required dangerous goods markings on each package inside the overpak or box. Do not place dry ice inside the pak.
- The name and telephone number of a person responsible must be marked on the package or provided on the airbill.
- The name and address of the shipper and recipient must be marked on the package.

Biological Substance, Category B (UN 3373) Marking Requirements

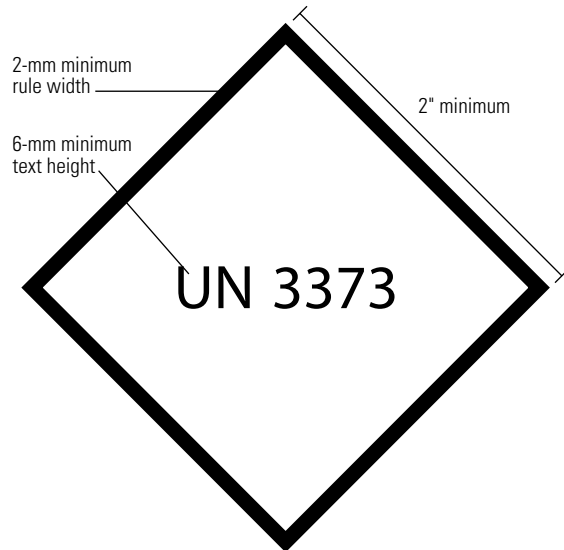

“Biological Substance, Category B” must appear in 6-mm-high text on the outer package adjacent to a diamond-shaped mark like the one shown here. The UN 3373 marking must be in the form of a square set at an angle of 45 degrees. Each side of the UN 3373 diamond should measure a minimum of 2” (50 mm). The width of the diamond rule line must be a minimum of 2 mm, and the letters and numbers must be at least 6 mm high.

FedEx UN 3373 Packaging Options

For your convenience, we offer the FedEx UN 3373 Pak, the FedEx Medium Clinical Box, and the FedEx Large Clinical Box as packaging options for your Biological Substance, Category B (UN 3373) shipments. We recommend the FedEx UN 3373 Pak for use when the sturdy outer packaging of your properly packaged shipment is smaller than 7" x 4" x 2" (minimum acceptable size).

To help increase your operational efficiencies and clearly identify this type of shipment, the FedEx UN 3373 Pak is preprinted with the required IATA UN 3373 marking, the proper shipping name, and the OVERPACK marking. FedEx clinical boxes will require the addition of proper IATA UN 3373 markings when used to ship Biological Substance, Category B (UN 3373) shipments.

The FedEx UN 3373 Pak can only be used to ship Biological Substance, Category B (UN 3373) shipments. If you need an overwrap for exempt clinical and environmental test sample shipments, use the FedEx® Clinical Pak.

To order the FedEx UN 3373 Pak, go to **fedex.com** or call 1.800.GoFedEx 1.800.463.3339.

FedEx Clinical Pak



FedEx Medium Clinical Box, FedEx Large Clinical Box



Packaging Restrictions

- Plastic bags and paper envelopes are unacceptable outer containers.
- The FedEx® Envelope, FedEx® Tube, FedEx® Pak, FedEx® Padded Pak, and FedEx boxes, including FedEx brown packaging offered at FedEx shipping locations, are not acceptable as outer containers for Biological Substance, Category B (UN 3373) shipments.
- The FedEx Clinical Pak cannot be used to ship Biological Substance, Category B (UN 3373) shipments.
- Only shipments classified as Biological Substance, Category B (UN 3373) can be shipped in the FedEx UN 3373 Pak.
- Biological Substance, Category B (UN 3373) shipments that are shipped refrigerated, frozen, on dry ice, or in liquid nitrogen must comply with current IATA and ICAO regulations.

If you have questions about whether your shipments require a biohazard label, consult the Occupational Safety and Health Administration (OSHA) for the applicable regulations.

NOTICE: This packaging brochure is provided to FedEx customers to help reduce loss or damage due to improper packaging. It is NOT intended to be a comprehensive guide for packaging items we accept for transit. We make no warranties, expressed or implied, regarding this information. Proper packaging is the sole responsibility of the shipper. For more information and comprehensive guidelines, contact the FedEx Dangerous Goods/Hazardous Materials Hotline at 1.800.GoFedEx 1.800.463.3339; press “81” or say “dangerous goods.” Refer to the current FedEx Service Guide for terms, conditions, and limitations applicable to FedEx® delivery services.

© 2012 FedEx. All rights reserved.

NOTE: Biological Substance, Category B (UN 3373) shipments are accepted at FedEx Express® Drop Box locations in the U.S. and Puerto Rico. FedEx Authorized ShipCenter® locations and FedEx ShipSite® locations (such as OfficeMax) do not allow such shipments. Go to **fedex.com** or call 1.800.GoFedEx 1.800.463.3339 to be directed to a FedEx location that can accept these shipments.

The FedEx Medium Clinical Box and the FedEx Large Clinical Box may be used to ship either non-infectious clinical samples or samples classified as Biological Substance, Category B (UN 3373), but they must be properly labeled. The shipper assumes sole responsibility for compliance with all applicable governmental regulations.

FedEx Office® Print and Ship Center locations, FedEx ShipSite locations, and FedEx Authorized ShipCenter locations in the U.S. do not accept shipments classified as Biological Substance, Category B (UN 3373). Go to **fedex.com** or call 1.800.GoFedEx 1.800.463.3339 to schedule a FedEx Express pickup, or to be directed to a FedEx location equipped to handle these shipments.

FedEx Packaging Services

FedEx Packaging Services offers package development consultation services. The FedEx Packaging Services lab does not test packaging containing Biological Substance, Category B (UN 3373) materials.

Contacts and Resources

- *How to Pack* guidelines at fedex.com/packaging.
- FedEx Dangerous Goods/Hazardous Materials Hotline, 1.800.GoFedEx 1.800.463.3339; press “81” or say “dangerous goods.”
- FedEx Dangerous Goods seminars and job aid at fedex.com/us/service-guide/our-services/dangerous-goods-hazmat/index.html.

NOTICE:

FedEx Express will refuse to accept packages that do not meet FedEx Express, government, or IATA and ICAO requirements. This brochure is in no way intended to replace requirements mandated by 49CFR and IATA. This is for informational purposes only.



Automotive and Mechanical Parts Packaging Guidelines and Designs

Responsible packaging can save you money and improve the safety and handling of your shipments. Follow these tips and design recommendations.

Contents

General Guidelines	36
Automotive Parts Best Practices	36
Shipping Methods and Minimum Packaging Requirements	36
Shipping in Corrugated Boxes	36
Shipping With Secure Wrapping and Padding	37
Shipping With a Forkliftable Base	38
Dangerous Goods/Hazardous Materials Guidelines	38
Packaging Designs for Automotive Parts	38
Packaging Freight Shipments	41
Sealing and Labeling Instructions	42
Contacts and Resources	42

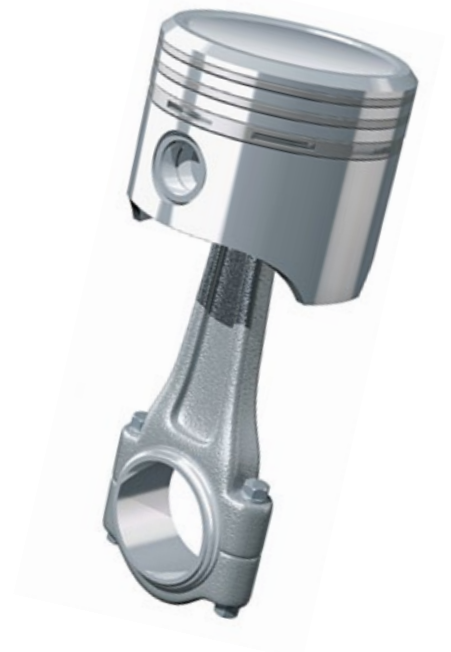

General Guidelines

- Pad all sharp edges, corners, and burrs of parts such as sheet metal or bare metal.
- Pad or cover precision-machined areas of parts, such as threads and fittings.
- Protect all parts that are susceptible to damage due to dents, scratches, and scuffing by using an appropriate amount of cushioning material and placing in a sturdy shipping container.
- Place documentation and shipping or routing labels on flat surfaces that will allow for maximum adhesion. Avoid placing labels around curved surfaces.
- Place all labels on the side with the largest surface area.
- Use FedEx tie-on tags, tire/crate labels, or plastic air-bill pouches instead of wire tags.

Automotive Parts Best Practices

- Ship engines, motors, transmissions, and chassis parts via FedEx Express® services.
- Drain and empty parts filled with lubricant fluids before shipping or demonstrate that the shipment is leakproof under all orientations.
- Help reduce damages and ensure safe working conditions for handlers by adequately packaging all mechanical or automotive parts.

Shipping Methods and Minimum Packaging Requirements

You are responsible for proper packaging when shipping; these tips should be helpful when packaging specific items. If items are not fully encased in an outside shipping container, an additional handling surcharge may apply. For complete terms and conditions, see the current FedEx Service Guide.

FedEx may reject any parts packaging that does not meet the minimum shipping standards for acceptance.

Shipping in Corrugated Boxes

When packaging parts, use adequate dunnage such as loosefill peanuts or other padding material to fill void spaces and prevent movement inside the box.

Wheels

Cushion the entire surface, and box chrome, painted, and decorative wheels that are susceptible to damage as a result of scratches or scuffing. Wrap non-decorative wheels in adequately taped clear plastic liner.

Flexplates, Flywheels

Pack flexplates and flywheels with adequate dunnage such as loosefill peanuts to fill void spaces in double- or triple-wall corrugated boxes, depending on the weight of the part. Apply "heavy" stickers to boxes exceeding 75 lbs.

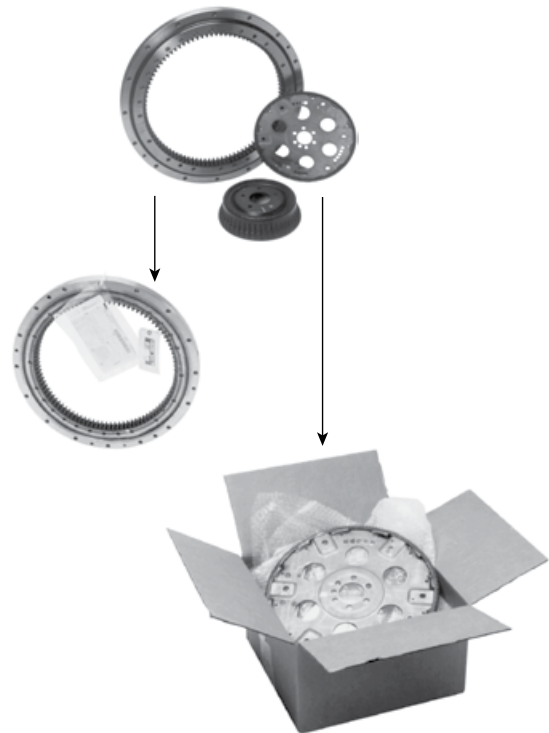

Car Doors, Hoods, Panels

Cushion and box all exposed metallic surfaces that are susceptible to damage as a result of scratches or dents.

Decorative Parts

Cushion and box all decorative parts such as grills that

may be unusable as a result of scratches, dents, bending, or scuffing.

Flexible Plastic Moldings

Cushion and box all flexible plastic moldings to prevent breakage or tearing.

Pad and cover protruding parts that might break or puncture the box.



Shocks, Coil Springs

Box cylindrical parts that can be packaged in tubes with adequate dunnage such as padding at the ends and loosefill peanuts to prevent puncturing through the end closures. Tag coil springs with a FedEx non-conveyable tie-on tag and adhere the shipping label to the tie-on tag if the item cannot be packaged in a tube or corrugated box.

Bumpers

Box bumpers that are susceptible to scratches or dents. Or wrap bumpers in adequately taped heavy-duty plastic bags and padding to protect any sharp or pointed corners.

Shipping With Secure Wrapping and Padding

When preparing irregular-shaped parts for shipment, tape cushioning material securely to help prevent removal during the handling process. We recommend placing the parts in a box in addition to the minimum requirements shown.

Moldings

Wrap non-decorative plastic moldings in adequately taped plastic film or bags, or cushion and box them.

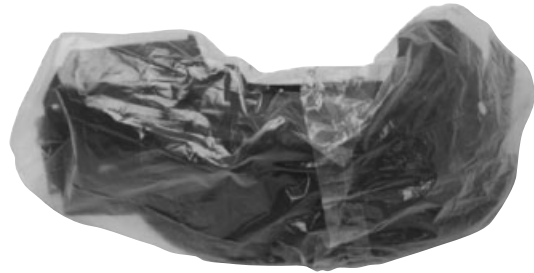

Sway Bars, A-Arms

Wrap sway bars, A-arms, and threaded rods in fiberboard or appropriate plastic film or bags and tape securely.



Exhaust System Parts, Leaf Springs

Pad and cover pointed and sharp edges with corrugated boards, adequate foam, or air-cellular cushioning material such as Bubble Wrap® and tape securely.



Tires

Place the tire/crate label on the tread of the tire and apply the FedEx shipping label on top of the tire/crate label. Request tire/crate labels by calling 1.800.GoFedEx 1.800.463.3339



Shipping With a Forkliftable Base

Secure transmissions and other parts weighing more than 150 lbs. to a forkliftable base compatible with pallet-jack usage. Banding to a pallet or bracing inside a corrugated container helps prevent damage in handling. For information on shipping freight, see the “Packaging Freight Shipments” section.

Transmissions, Engines

Drain the transmission of all fluids and place it in a plastic bag with absorbent padding below to absorb any residual fluid. When using expendable packaging, securely band it to its pallet, or block or brace it inside its corrugated container. If you use a reusable container, secure the transmission to the base with strapping.

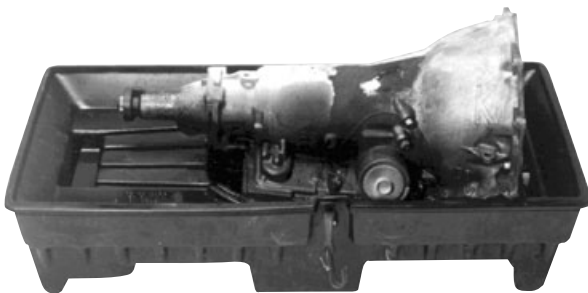

Dangerous Goods/Hazardous Materials Guidelines

Some of the most frequently shipped automotive and mechanical parts and accessories may be considered dangerous goods and hazardous materials. These include airbags, aerosols (some examples include paint and lubricants), batteries, engines and engine blocks with hazardous fuel, used fuel tanks, flammable paints, and touch-up paints.

Check with the manufacturer for the Material Safety Data Sheet (MSDS) for detailed information on the product. The shipper is responsible for correctly identifying, classifying, packaging, marking, labeling, and completing documentation for dangerous goods and hazardous materials. The Department of Transportation (DOT)/Federal Aviation Administration (FAA) require shippers to have job-specific dangerous goods training prior to tendering dangerous goods to FedEx or another air carrier. Reference the 49 Code of Federal Regulations (49CFR) 172.700 for complete details.

FedEx Express is required by law to report improperly declared or undeclared shipments of dangerous goods to the DOT. The shipper may be subject to fines and penalties under applicable law. Questions may be directed to the FedEx Dangerous Goods/Hazardous Materials Hotline, 1.800.GoFedEx 1.800.463.3339; press “81” or say “dangerous goods.”

Packaging Designs for Automotive Parts

At FedEx we know packaging, and we’re available to help you design automotive packaging that protects your parts. We may even help you save money with packaging that weighs less and is easier to make than your current designs.

Our FedEx package-design engineers develop packaging for parts every day. Most designs use cost-effective corrugated cushioning material and molded components to help prevent damage during transit. Best of all, each design passes FedEx test procedures and is available for you to use.

Our team offers consultation services, specifications, and computer-aided design (CAD) drawings to assist your packaging producer with development of your mechanical and automotive packaging.

Here are just a few of our designs.

Flat-Style Hood Design

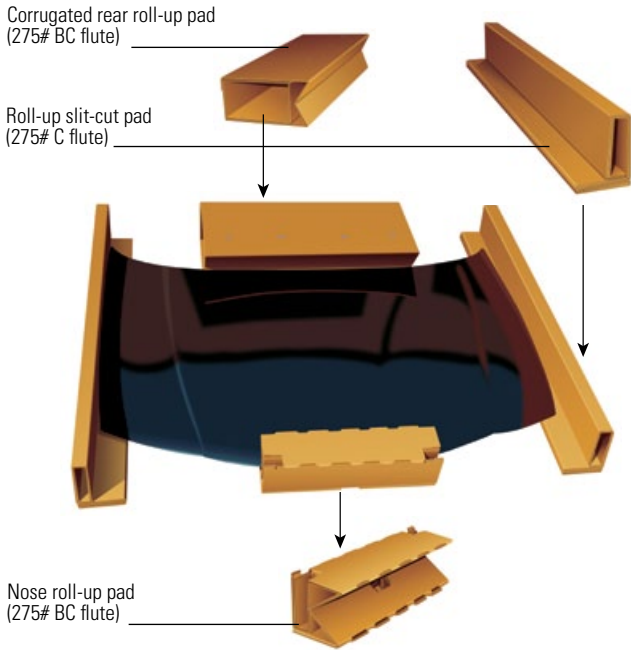

With this design, you center the nose and rear roll-up pads and staple them to the inner flaps of the end-loaded full-overlap shipping container. Place the hood in the container followed by roll-up slit-cut pads. Close and tape.

Hood and cushioning are placed inside a 275# BC flute full-overlap corrugated shipping container before shipping.

Grill-Style Hood Design

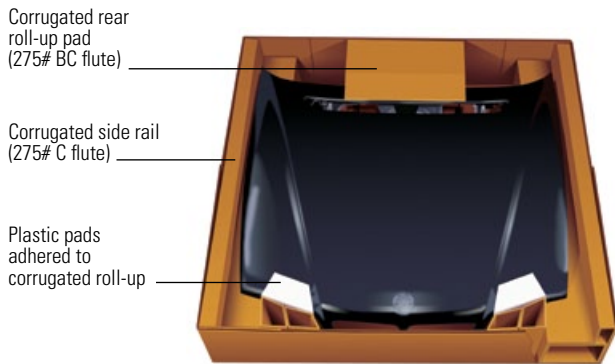

This design incorporates side rails to elevate and suspend the hood. The air space created by the elevation helps protect the grill from external forces.

Before shipment, place the hood and cushioning inside a 275# BC flute full-telescope corrugated shipping container for protection and stability.

Overbox-Style Hood Design

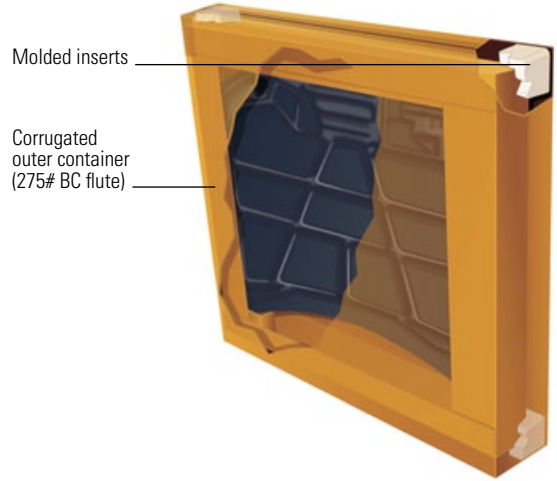

This design uses molded pulp inserts on all four class A sides of the inner container to help provide cushioning.

Before shipment, place the hood and cushioning inside a 275# BC flute corrugated shipping container for support and protection.

Trunk-Pack Design

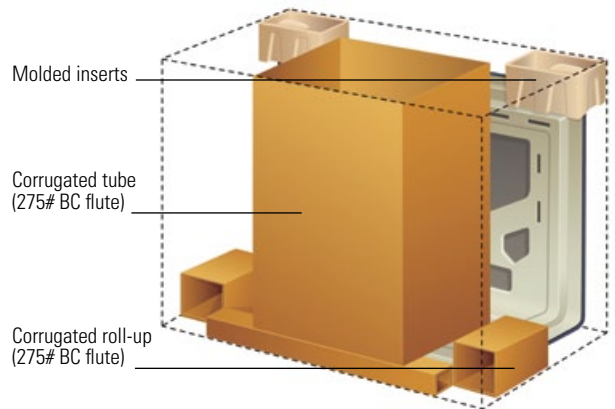

This design helps protect the trunk pack from external forces. Molded inserts are used to create air cells and brace the trunk lid.

Once the inserts are in place, place both the trunk lid and cushioning inside a 275# BC flute full-overlap corrugated shipping container for protection.

Door-Pack Design

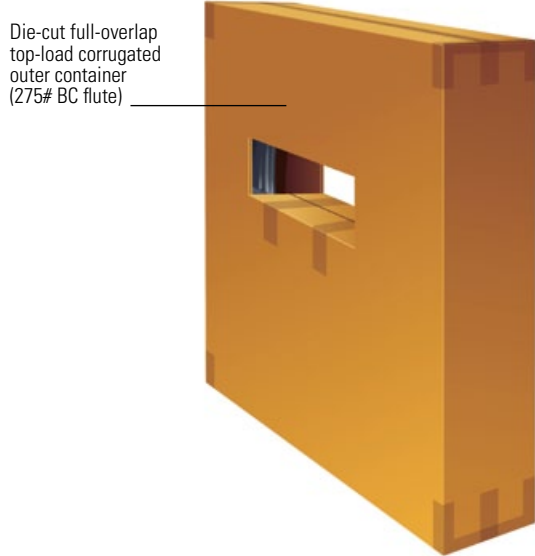
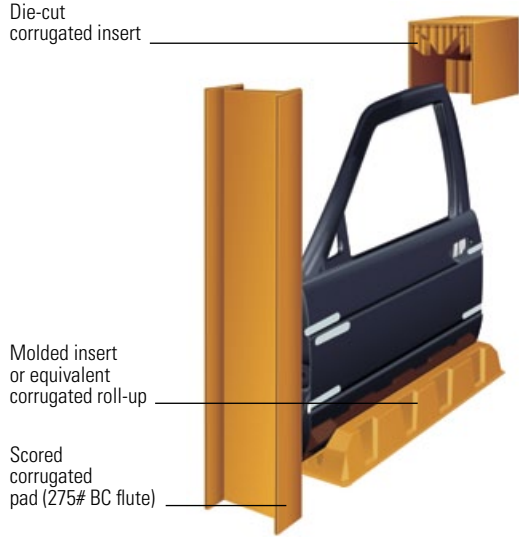

This design combines the use of a scored pad, a die-cut corrugated insert, and a molded insert to help provide cushioning and bracing of the door inside the outer shipping container.

Once roll-ups and pads are attached to the door, place both the door and cushioning inside a 275# BC flute corrugated shipping container for protection.

Windshield-Pack Design

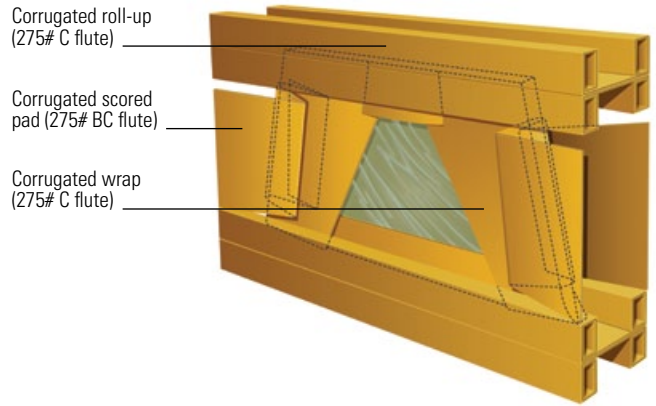

This design helps protect windshields from shock and/or torque during transit. The wrap converts a non-rigid part into a rigid surface so it can be cushioned and braced off of the corrugated wrap.

Before shipment, place the windshield and cushioning inside a full-overlap 275# BC flute corrugated shipping container.

Rim-Pack Design

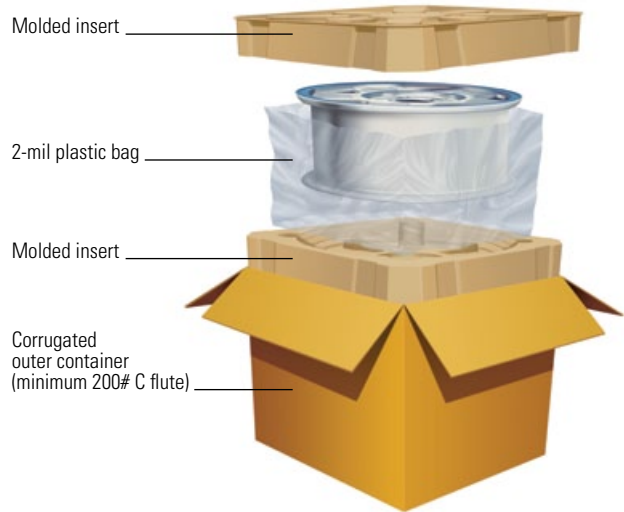

This design protects the rim from dents, scratches, and abrasions. The molded inserts are designed to fit multiple sizes.

Fascia- (Bumper Cover) Pack Design

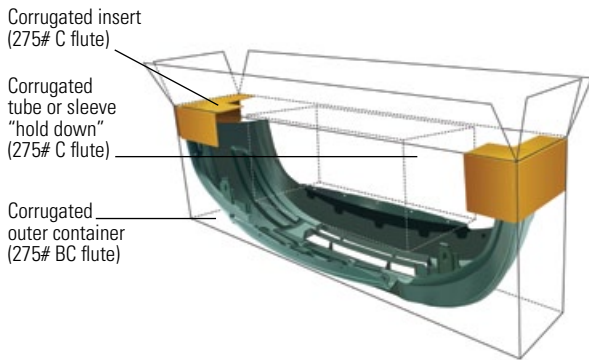

This design protects the fascia from scratches and abrasions. Additional poly-bag surface protection is optional.

Before shipping, place the fascia inside a 275# BC flute corrugated full-overlap shipping container. Then place inserts and the tube or sleeve into position.

Trim or Molding Pack Design



This rigid outer package design protects the pre-paint trim or moldings from scratches and bending.

Trim Sonopost to fit the part length. Insert the covered trim or molding into the corrugated outer container, and tape both ends with minimum 2"-wide pressure-sensitive plastic tape.

Call 1.800.377.2692 for information on Sonoco's Sonopost Technology.

Packaging Freight Shipments

Shipments that qualify as freight must be packaged accordingly. See the current FedEx Service Guide to determine if your shipment qualifies as freight.

For detailed information on preparing freight shipments, refer to *Packaging Guidelines for Shipping Freight* at [fedex.com/us/service-guide/our-services/package-freight/index.html](https://www.fedex.com/us/service-guide/our-services/package-freight/index.html).

You must package your freight shipments to allow for stacking of other packages on top of your shipment. Make sure your freight shipments are banded and stretchwrapped to the pallet, with the bands running in both directions. (Pallet loads secured with only stretch-wrap are not acceptable.)

Avoid corrugated or fiberboard pallets. You must secure all freight shipments weighing 151 lbs. or more on a forkliftable base, compatible with pallet-jack usage. The minimum specifications for a typical base for forklift or pallet-jack configuration are illustrated below.

Express Freight Shipments

To lessen the possibility of damage or delay to your cargo, make sure that all single-piece cargo greater than 150 lbs. is banded on all sides with heavy-duty metal or break-resistant plastic banding.

If your cargo is a single piece contained within a hardened container (plywood, metal) and is greater than 150 lbs., it does not require banding if exterior locks or clamps are used. (Glue, nails, or screws are not sufficient.)

Minimum Freight Specifications, Typical Base, Forklift or Pallet-Jack Configuration

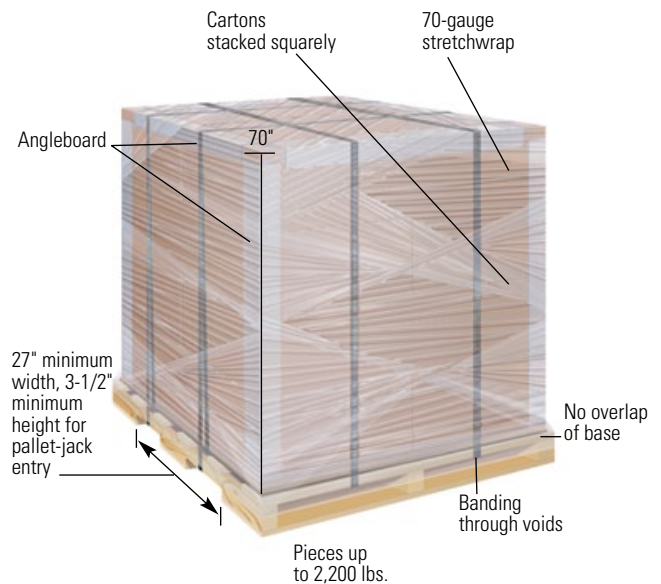

Sealing and Labeling Instructions

- When sealing corrugated outer containers, apply at least three strips of pressure-sensitive adhesive plastic tape that is at least 2" wide to both the top and bottom of the carton.
- Tape all seams or flaps using the H taping method.
- Place the shipping label on the top of the largest side.
- When shipping parts that cannot be packaged in corrugated outer containers, tag them appropriately.
- Tag wrapped and padded parts with a FedEx non-conveyable tie-on tag and adhere the shipping label to the tie-on tag.
- To request tie-on tags or cable ties, call 1.800.GoFedEx 1.800.463.4449. You may also contact your account executive for supplies.

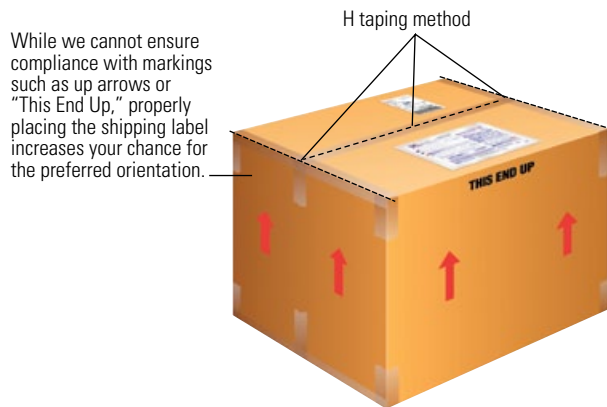

Contacts and Resources

- *How to Pack* guidelines at fedex.com/packaging.
- FedEx Packaging Services lab, packagingservices@fedex.com or 1.800.633.7019.
- FedEx Dangerous Goods/Hazardous Materials Hotline, 1.800.GoFedEx 1.800.463.3339 (say "dangerous goods").
- FedEx Service Guide at fedex.com/us/services for additional handling surcharge information.

Bubble Wrap is a registered trademark of Sealed Air Corporation. Sonopost is a registered trademark of Sonoco Products Company.

NOTICE: This packaging brochure is provided to FedEx customers to help reduce loss or damage due to improper packaging. It is NOT intended to be a comprehensive guide for packaging items we accept for transit. We make no warranties, expressed or implied, regarding this information. Proper packaging is the sole responsibility of the shipper. For more information and additional guidelines, go to the packaging tips page on fedex.com/packaging, email packagingservices@fedex.com, or contact FedEx Packaging Services at 1.800.633.7019. Refer to the current FedEx Service Guide for terms, conditions, and limitations applicable to FedEx® delivery services.

© 2012 FedEx. All rights reserved.

Packaging Battery Shipments

Follow these instructions to help ensure safe transportation of your battery shipments and your shipments with items containing batteries within the FedEx Express® network.

Contents

Unique Risks Associated With Shipping Batteries	44
Preparing Charged Batteries for Shipment	44
Shipping Wet Batteries	44
Shipping Dry Batteries	45
Shipping Lithium Batteries	45
Sealing and Labeling Instructions	47
Battery Shipment Restrictions and Regulations	47
FedEx Packaging Services	47
Contacts and Resources	47



Unique Risks Associated With Shipping Batteries

Batteries provide the power source for personal computers, phones, automobiles, and life-saving appliances. However, batteries are classified as dangerous goods, because by definition they produce electricity from a chemical reaction. When improperly handled, packaged, or stored, batteries pose a risk for corrosive chemical and electrical fires. Emphasis must be placed on safety when packaging and transporting them. Following is an overview of the requirements for acceptance and transport of batteries with the FedEx Express system.

Preparing Charged Batteries for Shipment

At FedEx Express, we understand the importance of ensuring the safe transport of your shipments. Charged battery shipments or shipments with items that contain charged batteries may overheat and ignite in certain conditions and, once ignited, may be difficult to extinguish or may expend corrosive substances.

By following these guidelines and complying with all applicable local, state, and federal laws governing packing, marking, and labeling, you can do your part to help ensure your shipments arrive safely and on time to their final destinations. FedEx Express strictly adheres to International Air Transport Association (IATA) and International Civil Aviation Organization (ICAO) regulations.

Shipping Wet Batteries

Wet batteries or wet-cell batteries are typically filled with corrosive acid or alkali and are regulated battery shipments (Class 8 — Corrosive). Wet batteries are common in vehicles, utility systems, un-interruptible power systems, and industrial machinery. These commodities must be correctly identified, classified, packaged, marked, and labeled. Additionally, the package must have the Shipper's Declaration for Dangerous Goods completed and signed by a trained shipper.

UN Numbers and Proper Shipping Names for Wet Batteries

- UN 2794, Batteries, wet, filled with acid (electric storage)

- UN 2795, Batteries, wet, filled with alkali (electric storage)
- UN 2800, Batteries, wet, nonspillable

General Wet Battery Packaging Guidelines

- Package wet-cell batteries in containers, including metal containers, with acid/alkali leakproof liner — sealed to prevent leakage.
- Fasten batteries securely with fill openings and vents facing up to prevent short-circuiting or overheating.
- Position multiple batteries side by side, separated by nonconductive dividers.
- Place contents in a sturdy outer container.

Shipping Nonspillable Wet Batteries

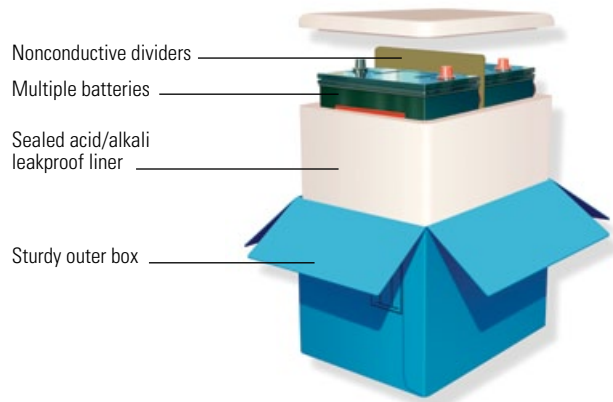

In accordance with 49CFR§173.159 and USG-11, an IATA (USG-11) nonspillable wet electric storage battery may be regarded as not subject to the regulations if the battery and its outer packaging are plainly and durably marked "NONSPILLABLE" or "NONSPILLABLE BATTERY." The battery must also meet the conditions for being regarded as not subject to the regulations as prescribed in Special Provision A67, meaning that no shipper's declaration is required.



Shipping Dry Batteries

Dry batteries are sealed, nonvented batteries used in flashlights or small appliances. They contain zinc salts and other solids or may be packed in combination with other metals. These batteries include non-rechargeable alkaline batteries and rechargeable batteries made with nickel metal hydride and nickel cadmium. Some dry batteries are regulated battery shipments (Class 4 — Dangerous When Wet or Class 8 — Corrosive) and must be correctly identified, classified, packaged, marked, and labeled.

UN Numbers and Proper Shipping Names for Dry Batteries

- UN 3028, Batteries, dry, containing potassium hydroxide, solid
- UN 3292, Batteries, containing sodium

General Dry Battery Packaging Guidelines

- Position multiple batteries or packages of batteries side by side, separated by dividers.
- Make sure batteries contained in an electronic device remain inside the device when shipping.
- Pack securely and fill void spaces to prevent shifting or movement in transit.
- Place contents in a sturdy outer container.

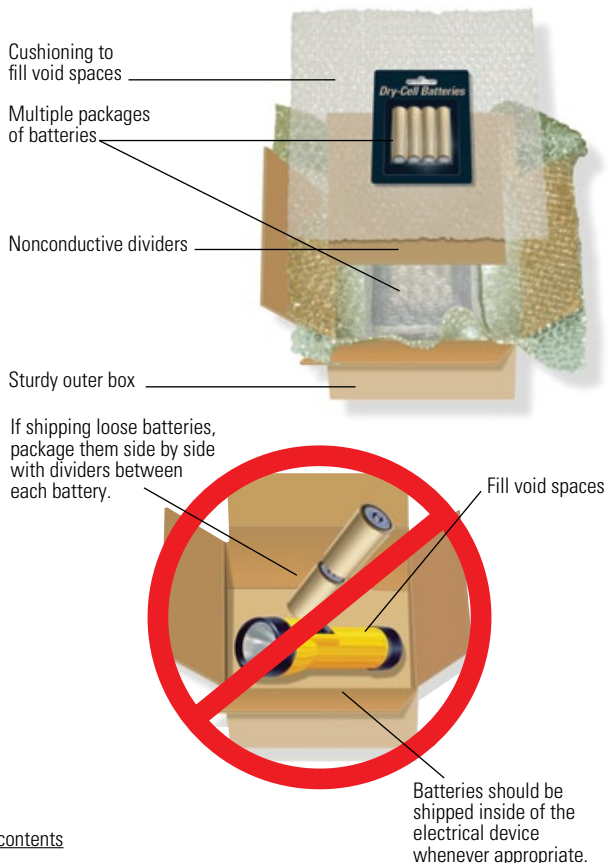

Shipping Lithium Batteries

Lithium batteries are commonly used in devices like mobile phones, laptops, PDAs, watches, cameras, and even children's toys. Lithium battery shipments or shipments with items that contain charged batteries may overheat and ignite in certain conditions and, once ignited, may be difficult to extinguish. The two main types of lithium batteries are lithium metal (primary non-rechargeable) and lithium ion (rechargeable).

UN Numbers and Proper Shipping Names for Lithium Batteries

- UN 3480, Lithium ion batteries
- UN 3481, Lithium ion batteries packed with equipment
- UN 3481, Lithium ion batteries contained in equipment
- UN 3090, Lithium metal batteries
- UN 3091, Lithium metal batteries packed with equipment
- UN 3091, Lithium metal batteries contained in equipment

Lithium metal batteries (primary non-rechargeable), UN 3090 prepared in accordance with Section IA, Section IB, and Section II of IATA packaging instruction 968 require approval prior to shipping by FedEx Express (operator variation FX-07). Go to [fedex.com](https://www.fedex.com) and enter "lithium batteries" in the search field to learn about the approval process.

FedEx Express will not accept lithium battery shipments containing or overpacked with items identified as Class or Division 1, 2.1, 2.2 (if CAO), 3, 4, 5, and 8, whether primary or subsidiary risk.

Section II IATA Lithium Battery Shipments

All packages containing lithium batteries are classified as Class 9 — Miscellaneous Dangerous Goods. However, packages containing small amounts of lithium may be exempted from most of the IATA and ICAO requirements if they comply with the requirements in Section II IATA (which matches Section II ICAO) Packing Instructions (PI) 965, 966, and 967 for lithium ion batteries and 968, 969, and 970 for lithium metal batteries as appropriate.

Shipments of lithium metal batteries, lithium metal batteries packed with equipment, and lithium metal batteries contained in equipment may be packaged in accordance with Section II IATA (Section II ICAO) packaging requirements provided that the metal or alloy cell content does not exceed more than 1g, and the aggregate lithium content does not exceed 2g per cell.

Lithium ion cells and batteries meeting the requirements of Section II must meet the general requirements of the packaging instruction. For lithium ion or polymer cells, the watt-hour rating is not more than 20Wh and 100wh per battery.

Each of the six proper shipping names defined in Section II IATA may have additional requirements related to types of approved outer packaging, weight limits, and package drop tests of 1.2m.

Fully regulated lithium battery outer packaging must meet Packing Group II performance standards. (See Packaging Requirements as outlined in IATA Dangerous Goods Regulation).

Section II Lithium Battery Packaging Guidelines

To comply with Section II IATA shipping requirements, shipments containing lithium batteries and cells must comply with specific packaging guidelines.

- Ensure that lithium batteries are individually packaged in fully enclosed inner packaging such as a plastic blister wrap or pasteboard to provide protection for each battery.
- Shield and protect lithium batteries to prevent short circuits or contact with conductive materials within the packaging that could cause short circuits.
- Ensure that packaging is proven (i.e., tested) to meet the requirements of each test in the UN Manual of Tests and Criteria, Part III, Sub-Section 38.3.
- Make sure that lithium batteries are completely enclosed (such as in equipment or surrounded by plastic with void space filled to prevent movement), except when the proper shipping names end with “contained in equipment.”

- Place contents in a sturdy outer container.
- Provide correct labeling and documentation.

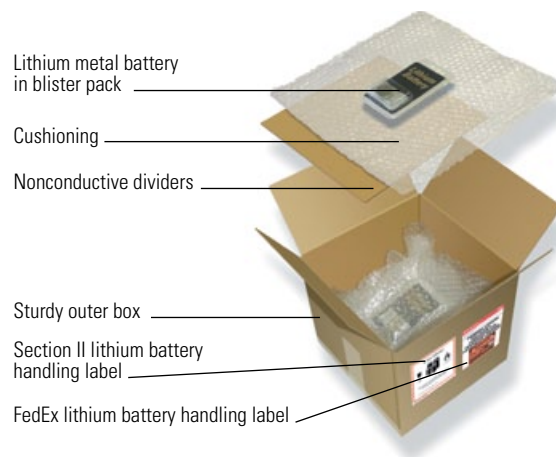

Section IA IATA Lithium Battery Shipments

Lithium batteries, both lithium ion and lithium metal, are fully regulated dangerous goods when prepared under Section IA IATA regulations. These commodities must be correctly identified, classified, packaged, marked, and labeled. Additionally, the package must have the Shipper’s Declaration for Dangerous Goods completed and signed by a trained shipper.

Section IB IATA Stand-Alone Lithium Battery Shipments

Section IB requirements apply to lithium metal cells with a lithium metal content not exceeding 1g and lithium metal batteries with a lithium metal content not exceeding 2g packed in quantities that exceed the allowance permitted in Section II, Table 968-II. Per FX-07, FedEx Express requires all 1B shipments to have a Shipper’s Declaration for Dangerous Goods, and “1B” must be indicated in either the Authorization or Additional Handling section. Alternate documentation will not be allowed. Refer to packaging instructions 965 and 968.



Sealing and Labeling Instructions

Although these instructions are not regulatory requirements, they represent FedEx best practices when shipping with corrugated boxes.

- Using the H taping method, apply at least three strips of pressure-sensitive adhesive plastic tape that is at least 2" wide to both the top and bottom of the carton.
- Tape all seams or flaps.
- Place the shipping label on the top of the largest side.
- Ensure that all required outer markings, labelings, and documentation appear.

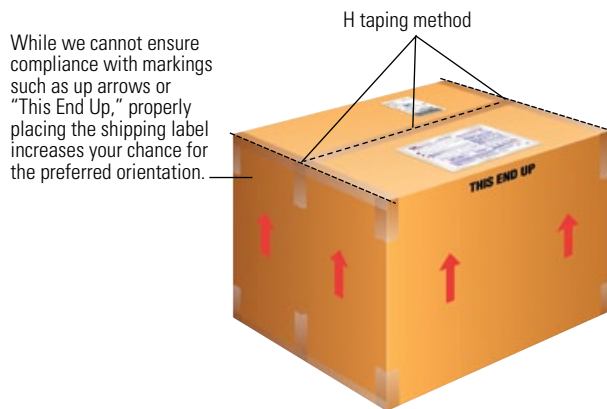

Battery Shipment Restrictions and Regulations

FedEx Express will not accept or ship:

- Recalled or defective batteries, either as a stand-alone unit or contained with equipment.
- Recalled or defective lithium batteries contained in electronic equipment, such as a laptop.

(See IATA Special Provision A154 for additional details on these restrictions.)

FedEx Office® Print and Ship Center locations and FedEx World Service Center® locations do not accept regulated battery shipments, with the exception of lithium battery shipments meeting Section II IATA regulations.

This brochure is in no way intended to replace requirements mandated by 49CFR and IATA. This is for informational purposes only. This packaging brochure is provided to FedEx customers to help reduce loss or damage due to improper packaging. It is NOT intended to be a comprehensive guide for packaging items we accept for transit. We make no warranties, expressed or implied, regarding this information. Proper packaging is the sole responsibility of the shipper. For more information and comprehensive guidelines, contact the FedEx Dangerous Goods/Hazardous Materials Hotline at 1.800.GoFedEx 1.800.463.3339; press "81" or say "dangerous goods." (Outside the U.S., request to speak to a dangerous goods representative.) Refer to the current FedEx Service Guide for terms, conditions, and limitations applicable to FedEx® delivery services.
© 2012 FedEx. All rights reserved.

FedEx Packaging Services

FedEx Packaging Services offers package development consultation services. The FedEx Packaging Services lab does not test packaging containing items classified as dangerous goods.

Contacts and Resources

- *How to Pack* guidelines at fedex.com/packaging.
- FedEx Dangerous Goods/Hazardous Materials Hotline, 1.800.GoFedEx 1.800.463.3339; press "81" or say "dangerous goods."
- FedEx Dangerous Goods training seminars and job aid at <http://www.fedex.com/us/service-guide/our-services/dangerous-goods-hazmat/index.html>.

NOTICE:

FedEx Express will refuse to accept packages that do not meet FedEx Express, government, or IATA and ICAO requirements.